

Northern Lights Beekeeping
2023 WAS/CDBA International Conference



The Frame Game

Northern Lights Beekeeping Conference

SEPTEMBER 30, 2023





15+ year hobbyist beekeeper – 15 to 20 hives

EAS Master Beekeeper

Past President – NWNJBA

Day Job > Medical Affairs IT, Bristol Myers Squibb

Beekeeping Podcaster

Managed Mentoring Program for Getting Started in Beekeeping

INTRODUCTION
– Kevin Inglin

Our Home Yard



FRAME DESIGN

Exploring Frame Design and its relationship with Bee Space



BEE SPACE STANDARDS

Building Bee Space Principles into Modern Hive Equipment



MANUFACTURER INPUT

Equipment standards are in the hands of the manufacturers



BEE SPACE VIOLATIONS

The perils of getting it wrong - Mismatch Equipment Problems



CONSTRUCTION & ADVICE

What you buy, and who you buy it from, is an Critical Consideration



PROBLEM AVOIDANCE

Some wisdom and guidance to consider to keep out of trouble



FRAME DESIGN

Exploring Frame Design and its relationship with Bee Space

FRAMES

They are the heart of the hive

- ❑ Beekeepers rarely stop to think about how important a role they play
 - *The Goal of this talk is to help you see the relationship of frames in beekeeping*
 - *Especially as they relate to mapping up to hive boxes*





MIND THE GAP

You do not want
problems with a
colony of live bees
in your equipment,
but....

**The key to this presentation
is about avoiding problems**

With the passage of time....

**WITH AN ACTIVE COLONY
IN THE HIVE**

You will inevitably come to
discover the challenges of

the FRAME GAME.



MIND THE GAP

You do not want
problems with a
colony of live bees
in your equipment,
but....

**The key to this presentation
is about avoiding problems**

In this session we will....

- *Focus on box construction and frames, and how they can trip you up.*
- *Will also talk about marketplace offerings*
- *And add a pinch of management practices*
- *And venture into some unconventional ideas*

the FRAME GAME.

Lorenzo Langstroth

□ Reverend Langstroth

- *Credited with being the first person to have recognized and describe the concept of **bee space**.*
- *His discovery, along with the discovery of a handful of other notable figures, led to the enablement of **"moveable comb" frames** in late 1800s*

Terminology

The Concept of Bee Space:

The space maintained as a practice by the bees in a natural nest

Maintaining bee space enables the bees to pass along freely.



Hoffman Frames (Europe circa 1860s)

□ Julius Hoffman

- *A student of Johann Dzierzon, he introduced the self spacing frame concept that led to today's design*

- Before the introduction of the Hoffman frame, beekeepers used frames that required additional spacers or distances between them to maintain proper spacing inside the hive.
- The Hoffman frame design gained popularity among beekeepers in Europe and other parts of the world due to its practicality and ease of use.
- It helped standardize hive dimensions and frame spacing.

□ Dzierzon's designs

- *Johann Dzierzon **1835***
 - Some indicate that modern designs, and specifically Langstroth's designs, may have been derived by Dzierzon's designs.
 - Dzierzon, like others, affixed the frames in a container (shell)

*Same Dzierzon from
Non-Langstroth Hives!*

Adoption of the Hoffman Self-Spacing Frame

❑ Promoted by Al Root in the 1890s

- *Al Root saw the Hoffman Frame designs, immediately recognized their advantage, and started promoting them.*
 - The frame started being published in the bee journals beginning around 1890.
 - The movable and self spacing Hoffman frame proved to be so advantageous it was quickly adopted.
 - The modern Langstroth is a merging of these two developments and has been the most common North American hive since around 1920
 - Langstroth Bee Space coupled with Hoffman Style Frames are now in use throughout the world.

Gleanings Bee Culture

Now, dear readers, if good and reliable witnesses say a thing is true, that either the Hoffman or closed-end frame is not an awkward implement to handle, but, on the contrary, possesses many decided advantages over the old hanging frame, let us not be so conservative as to block the wheels of progress. It may not be feasible or advisable for old bee-keepers of the hanging-frame school to change; but it may be an advantage for the new crop of bee-keepers coming on, to get started along the right track. Still further, as old combs are to be continually replaced in large yards more or less, it may be desirable for old bee-keepers to work in, for instance, the Hoffman, by degrees. Experimenting along in this way is quite safe, and is not likely to lead to any serious results, should this fixed-distance craze prove to be a mistake.

BEE SPACE STANDARDS

Building Bee Space Principles into Modern Hive Equipment

The Principle of Bee Space – 5/16th (~7.9 mm)

5/16-inch (7.9 millimeters)
is the sweet spot

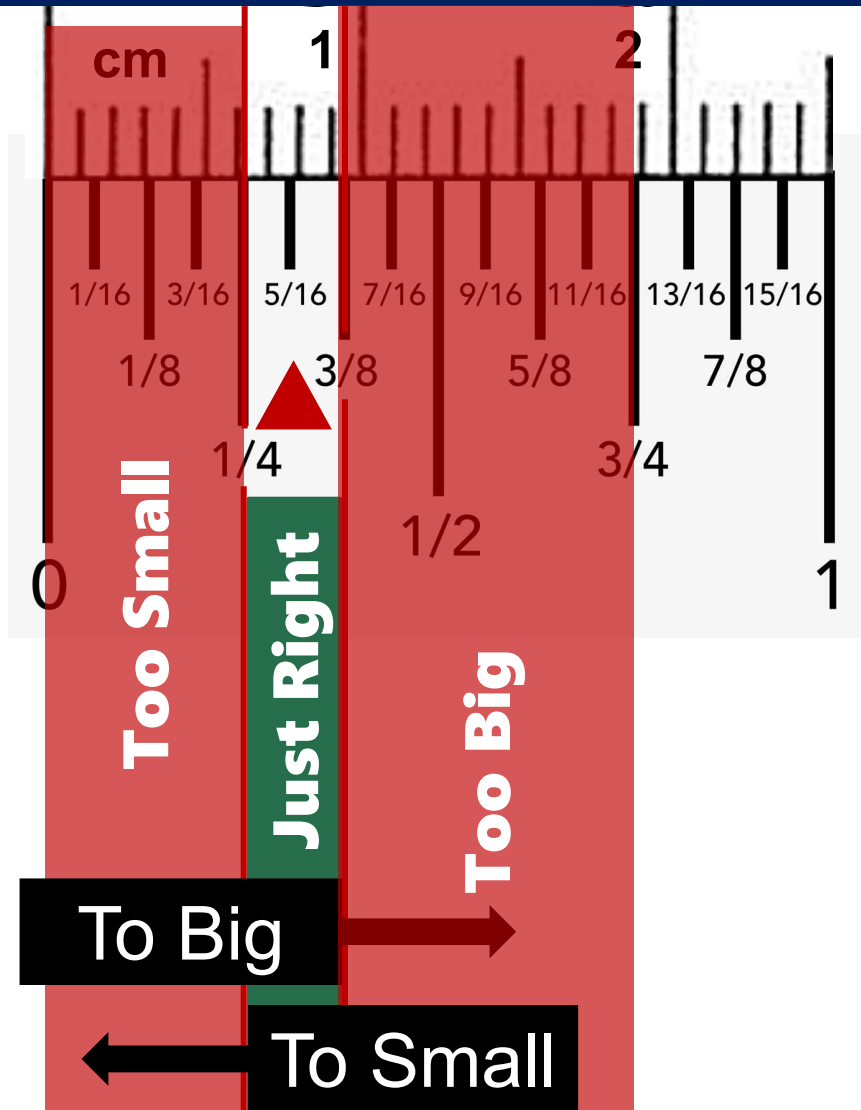

As a rule of thumb...

- ❑ Bees build **excess comb** in a space larger than 3/8" (.95cm)
- ❑ Bees will **fill any space** less than 1/4" (.64cm) with propolis.
- ❑ The space between 1/4" and 3/8" (.64 to .95 CM) is considered typical bee space.

5/16th is awesome



We all know bee equipment, right?

We think we do...

But as they say, the devil is in the details.

- *Bee space is finicky and maybe things are sneaking by us.*
- *Let's examine the most universal box in use: A 'standard' Langstroth deep.*

Frames Rest in Boxes

*As we start, let's explore
Beehive Box Dimensions*

Starting with a typical hive body (a deep)

- ❑ No worries, the size is universal.
- ❑ The answer is, True, and False...
 - *Kevin – How can that be?*
 - *Actually, Size and dimensions are in the hands of the manufacturer*
- ❑ Who sets the standard for the dimensions?
 - *Think on that for a second and then let's explore.*
 - *Do you trust Bee Source? Do you trust Penn State? How about Mann Lake?*

Right?

Standard Boxes are Standard *example 1*

Hive Dimensions: **BEE SOURCE Plans**

These Dimensions look good right?

Image credit: bee source posting

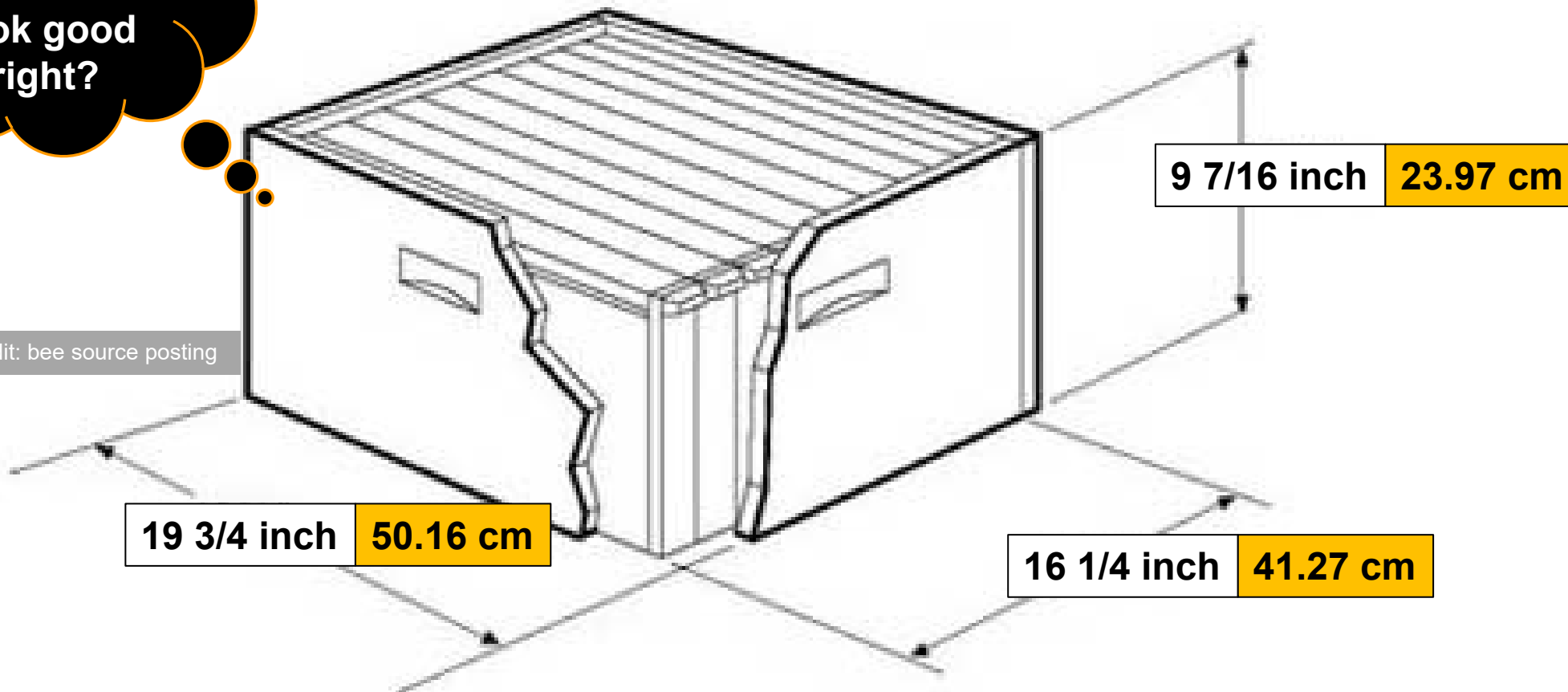

Standard Boxes are Standard *example 2*

Hive Dimensions: **PENN STATE** Guide

Here is another take from Penn State

Image credit: Penn State Guide for getting started in beekeeping

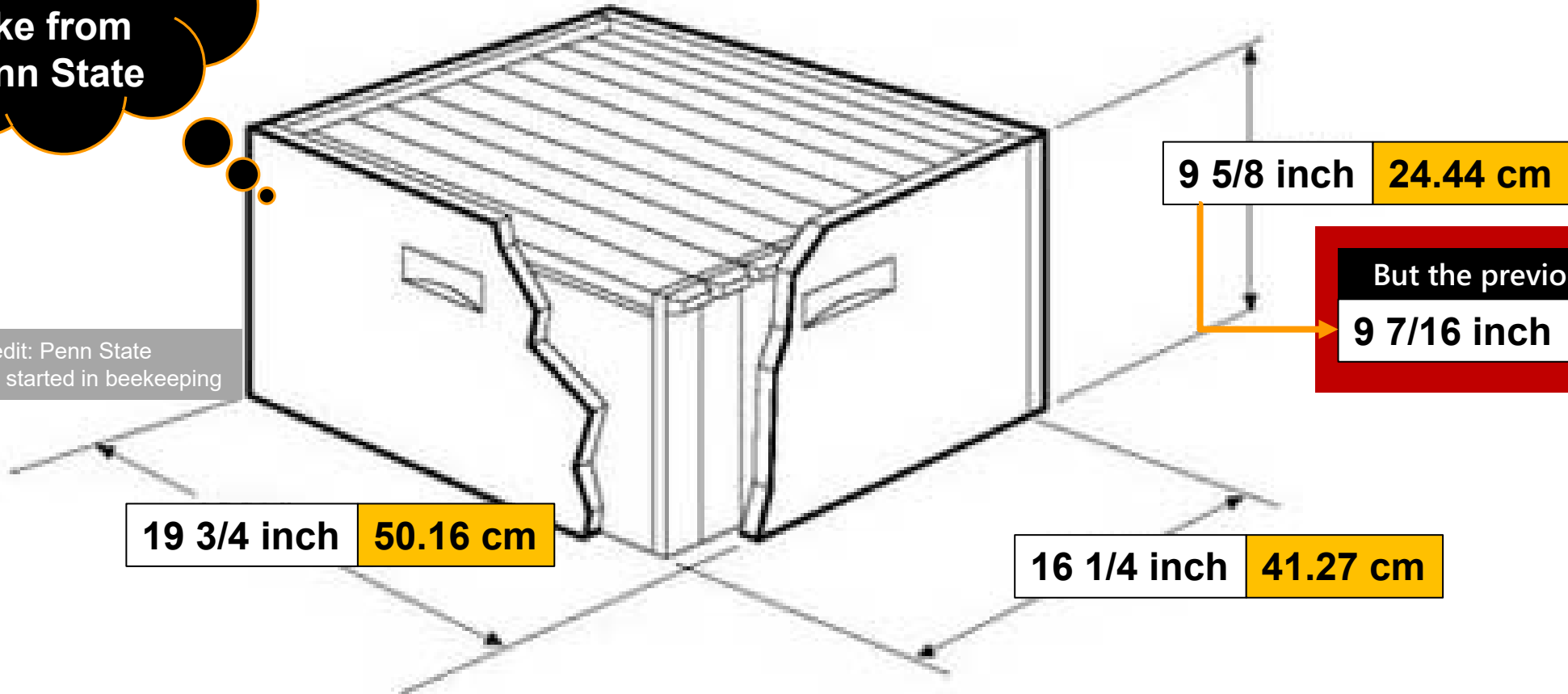

But the previous slide said
9 7/16 inch 23.97 cm

Standard Boxes are Standard *example 3*

Hive Dimensions: **MANN LAKE Mfg.**

Last One
Mann Lake
Bee Supply

Image credit: Mann Lake Catalog

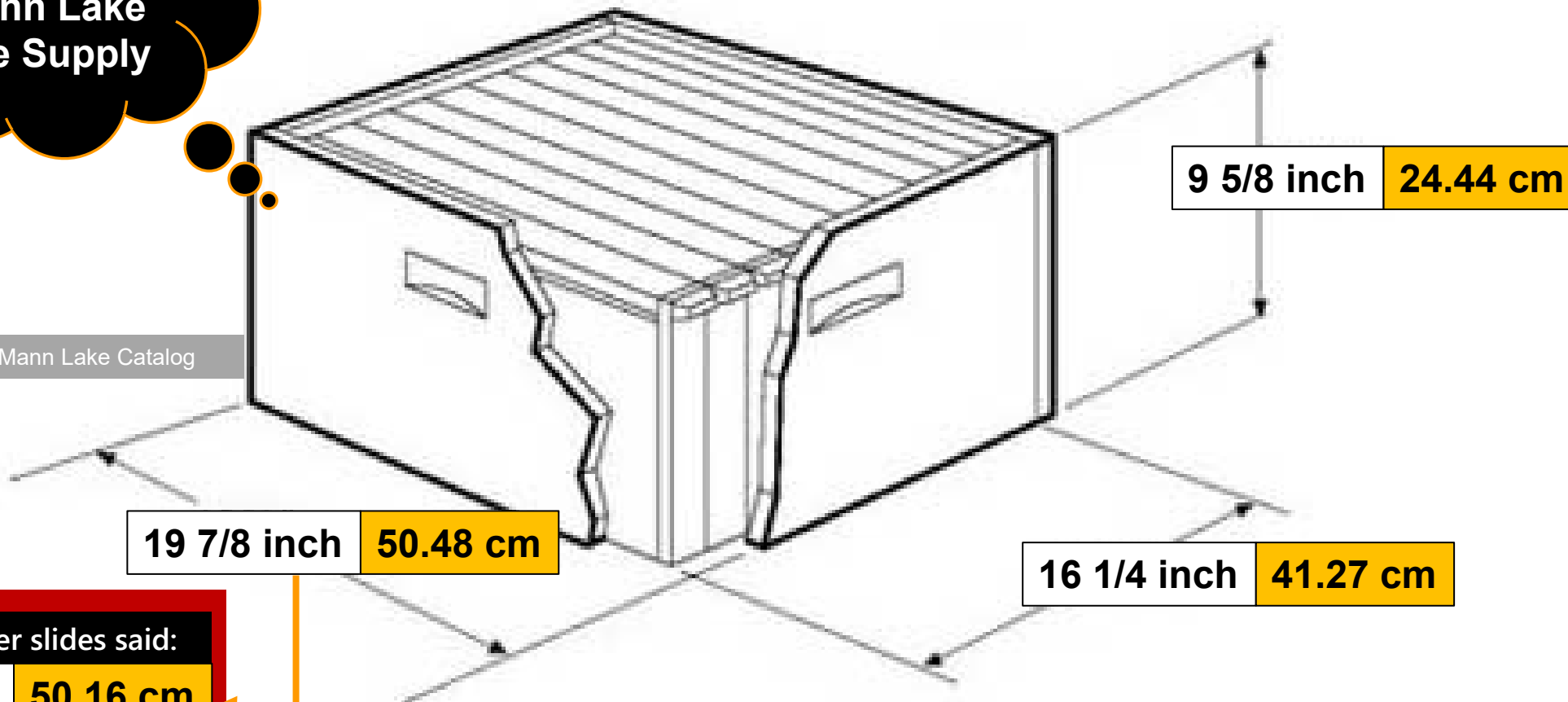

Wait, the other slides said:

19 3/4 inch 50.16 cm

Three trusted sources...*Who is Right?*

Source	Length	Width	Height
Bee Source	19 3/4"	16 1/4"	9 7/16"
Penn State	19 3/4"	16 1/4"	9 5/8"
Mann Lake Catalog	19 7/8	16 1/4"	9 5/8"

- Universally **big manufacturers** have settled on these standard dimensions...

19^(7/8) deep, **16^(1/4)** wide, **9^(5/8)** high
50.48 deep, **41.27** wide, **24.44** high

Note: These are measurements of the Outside dimensions

What of eBay and Amazon, etc.?

- ❑ Major manufactures should be considered the standard
- ❑ Fringe Outlets can be risky
 - Often times, less expensive equipment ends up being **not true to typical standard sizing**
 - Be careful with e-Bay deals, Amazon, and Facebook offers.

BEEHIVE 20 FRAME

10 DEEP 10 MEDIUM FRAMES

Image credit: eBay
Sales



What of eBay and Amazon, etc.?

- ❑ Major manufactures should be considered the standard
- ❑ Fringe Outlets can be risky
 - Often times, less expensive equipment ends up being **not true to typical standard sizing**
 - Be careful with e-Bay deals, Amazon, and Facebook offers.

BEEHIVE 20 FRAME

10 DEEP 10 MEDIUM FRAMES

100%
NATURAL
WOOD

By the way...
**It is 100%
Natural
So, it has
to be good**

And...
**I kind of prefer
handles cut into
my boxes!**



2 YEARS WARRANTY



Image credit: eBay Sales

MANUFACTURER INPUT

Equipment standards are in the hands of the manufacturers

Source	Length	Width	Height
Bee Source	19 3/4"	16 1/4"	9 7/16"
Penn State	19 3/4"	16 1/4"	9 5/8"
Mann Lake	19 7/8"	16 1/4"	9 5/8"

Is that *Interesting?*

- *Let's hold on to that for a moment.*
- *We are going to turn our attention to other points of interest.*

So, Box Sizes Can Differ

- We hope that hive body dimensions are universal
 - *At least, we learned, with the **big manufacturers that it is likely.***
- What about the Frame Rests?
- What about the Frame Designs?
- What about Frame Dimensions?
 - *These are at the discretion of the manufacturer*



Frames rest in a hive box Rabbet Joints

□ This is symbiotic relationship

- *The Relationship of how frames rest in the equipment is of utmost importance to bee space*
- *Rabbets very much play a role in how the frames interact in the bee equipment*

Terminology

Rabbet: A step-shaped recess cut along the edge or in the face of a piece of wood, typically forming a match to the edge or tongue of another piece.

Frame Rest ^

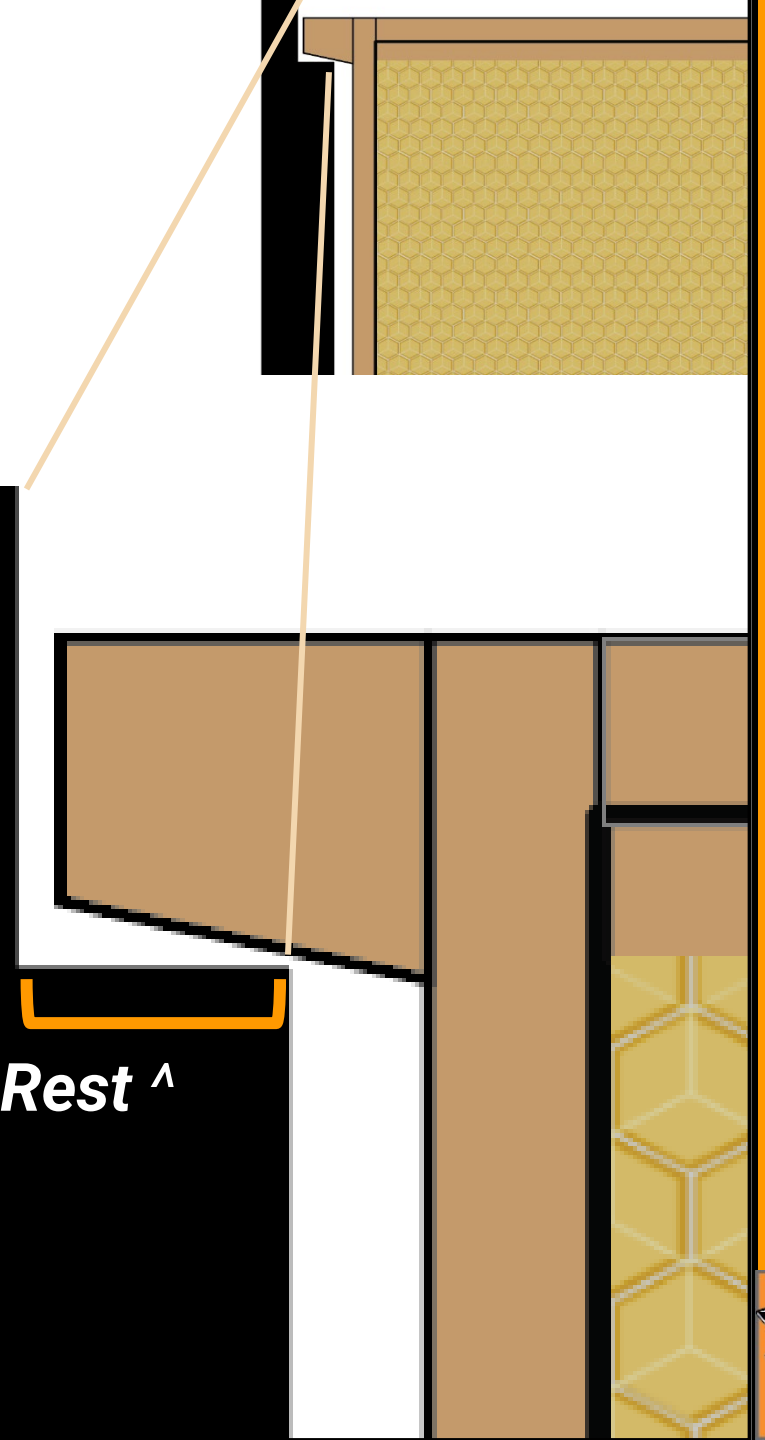

Rabbit Dimension PRIMER

Translates to...

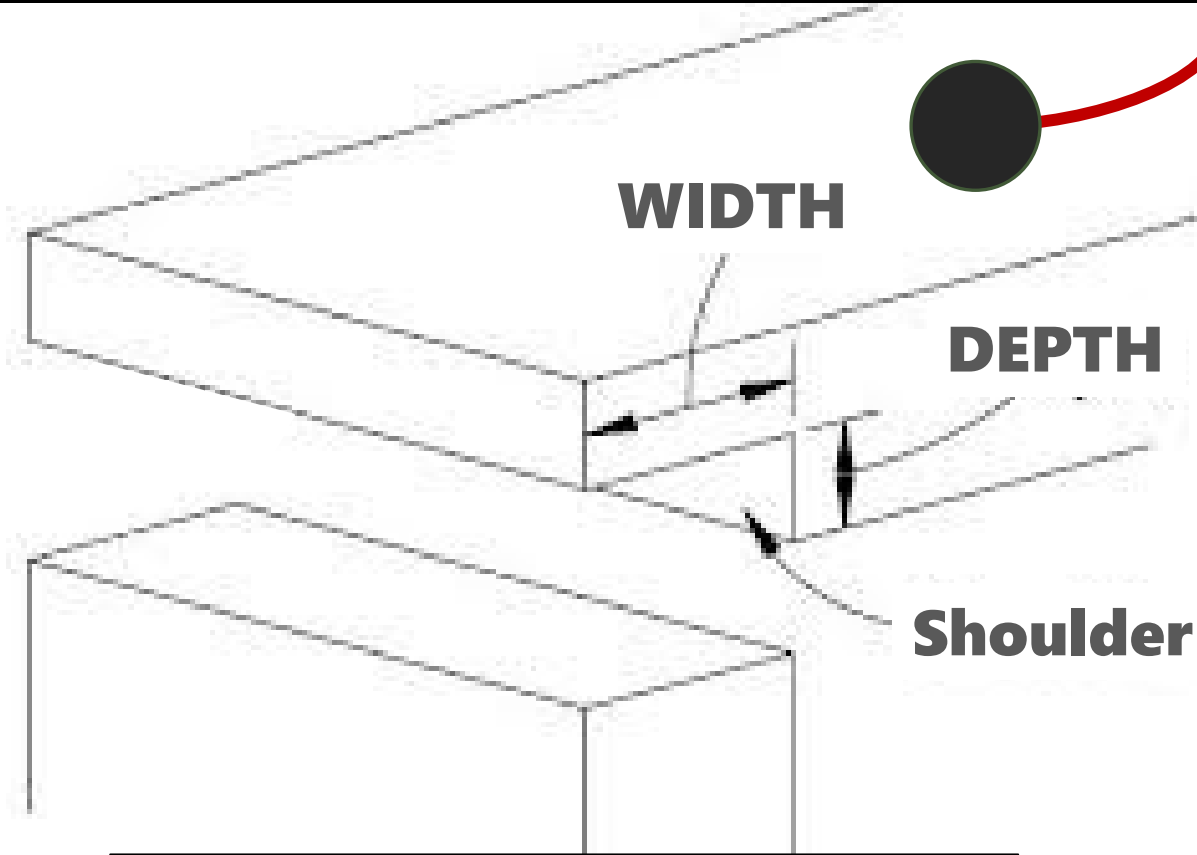

Rabbit Terminology

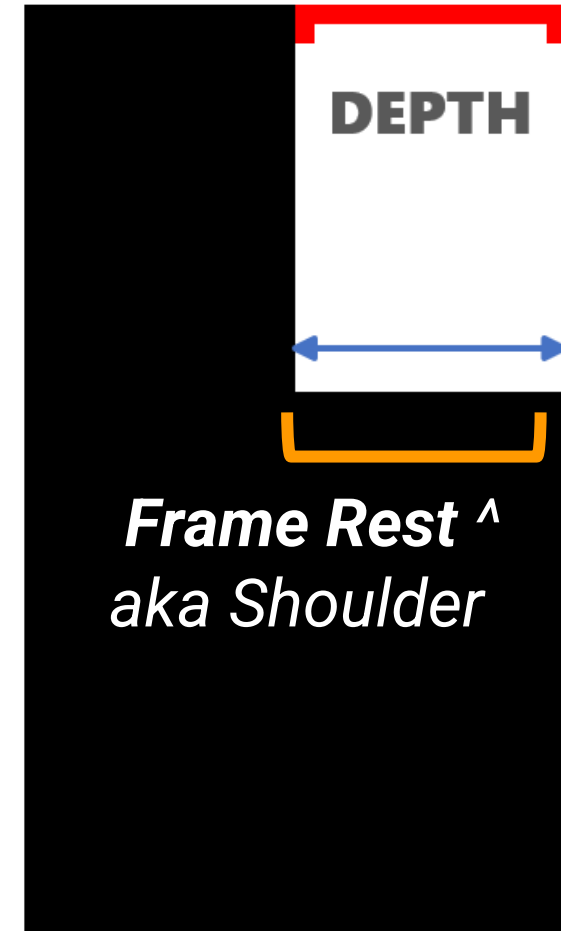
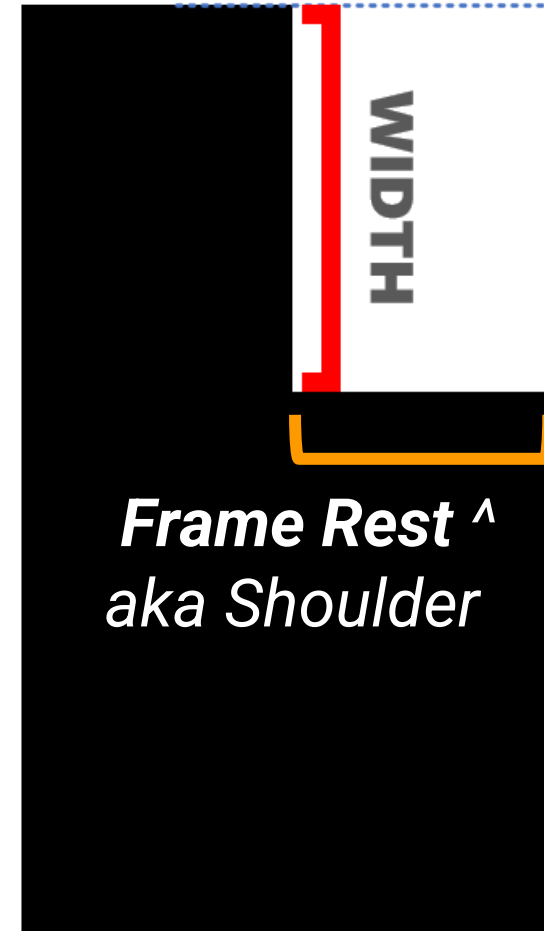

Baseline of the terminology helps us to explore the relationship of how frames settle in the frame rests

Rabbit Depth Review

Frame rests should be universal

Right?

...but alas they are not

- Typically, the depth of the rabbet is held true: **half the width** of the thickness of the wood being used

Reviewing the Depth

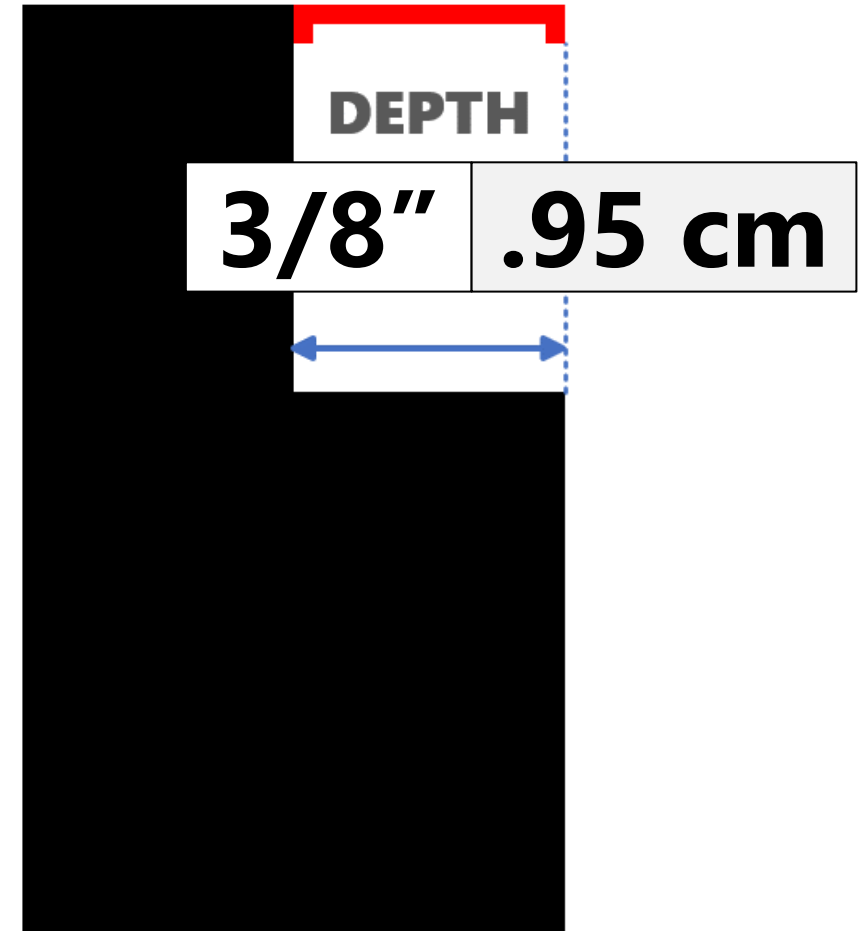

So, the measurement of the depth, no matter the manufacturer is almost always consistent

Rabbit Depth Review

Frame rests should be universal
Right?

...but alas they are not

Frame rest **widths** are a different story

❑ Rabbit Width

- *Is often at the discretion of the vendor*

Reviewing the Width

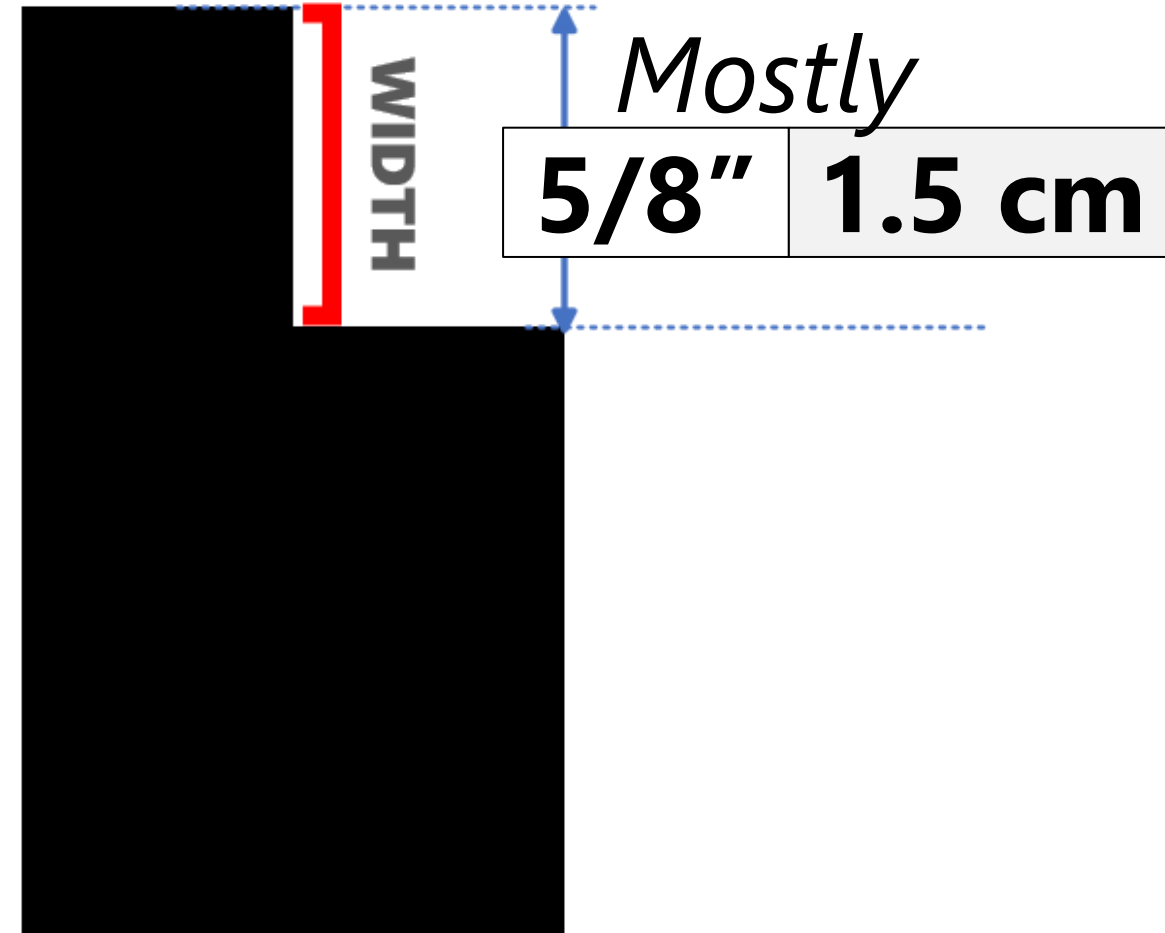

5/8ths (1.5cm) is a pretty common standard, but it is not always consistent with manufacturers

Rabbit Depth Review

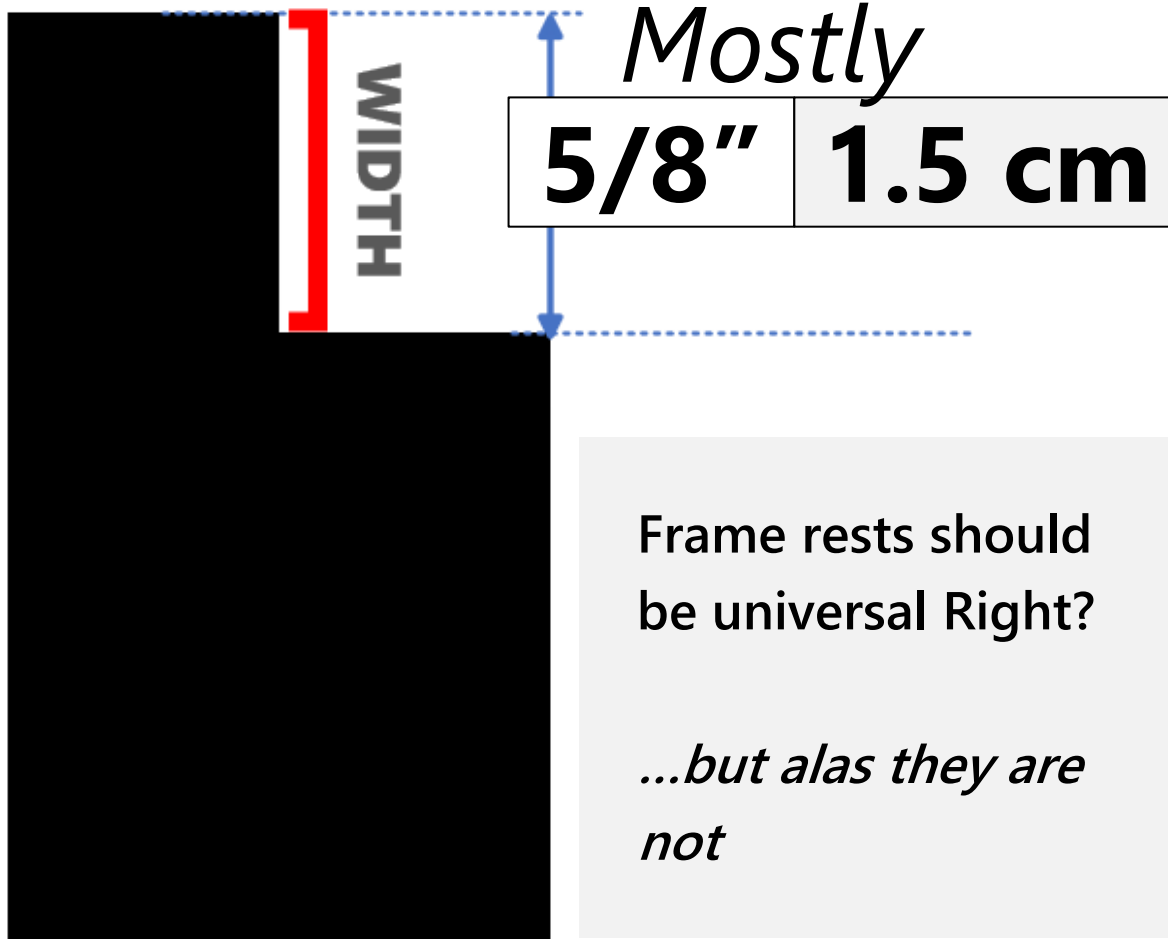

Mostly

5/8"	1.5 cm
-------------	---------------

Frame rests should be universal Right?

...but alas they are not

Reviewing the Width

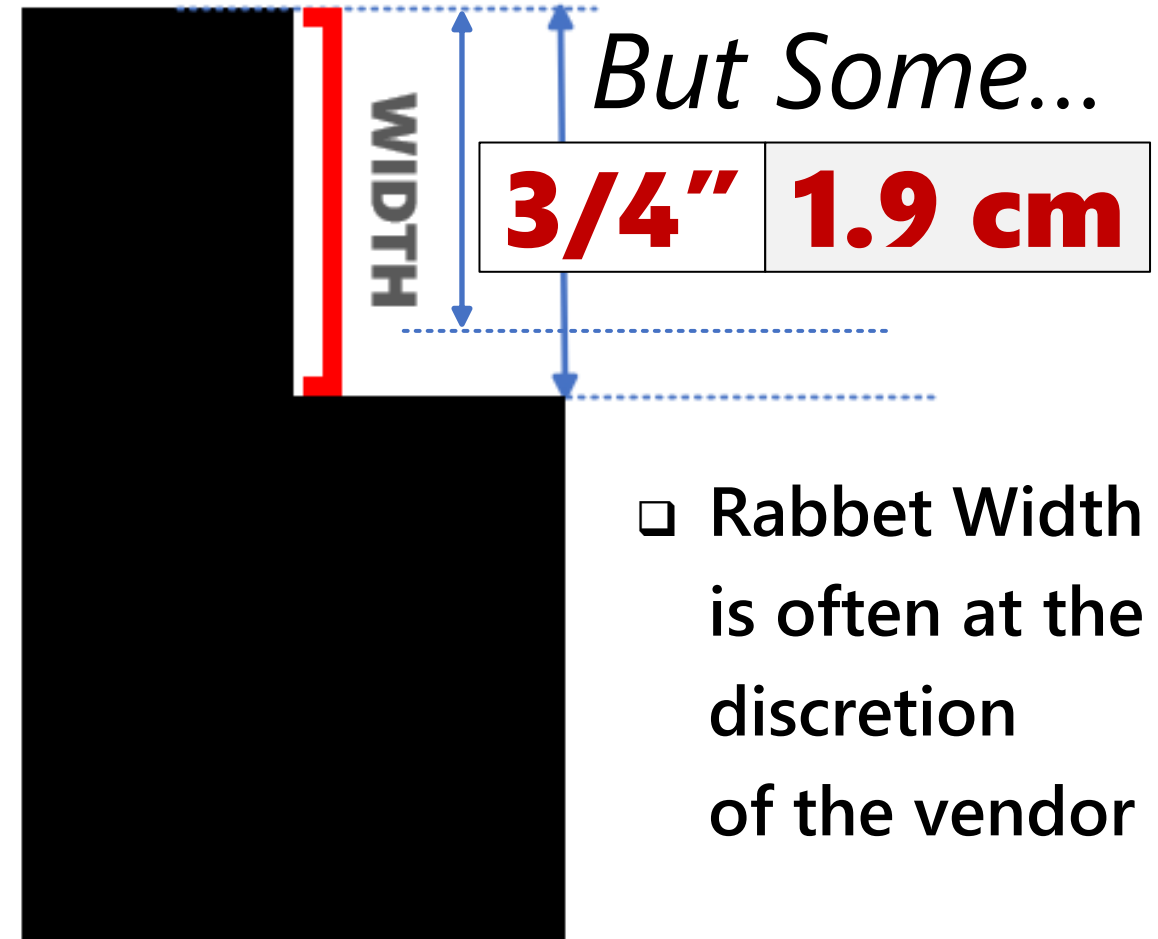

But Some...

3/4"	1.9 cm
-------------	---------------

- ❑ Rabbit Width is often at the discretion of the vendor

So, the measurement of the WIDTH, can vary from manufacturer to manufacturer

Additional Considerations

Frame Rest Protectors

□ 90° Protectors

- *These type of protectors are okay*
- *They generally do not introduce spacing problems*
- *And they serve to protect your woodenware*

□ Raised Protectors

- *These can be problematic*
- *You need to understand how they work in conjunction with your frames and woodenware*

Frame Rest Protectors are recommended – but be sure they are compatible with your setup

A Quick Poll



By Show of Hands *Raise your Hand if....*

- You Have ever purchased a Nucleus Colony
- You Have ever taken in outside Equipment
- You Have ever won a hive somewhere
- You Have your supplier go out of business
- You Purchased equipment from a Small Supplier
- Exchanged a piece of equipment with another
- You have been beekeeping for more than 5 years
- You Purchased errant hive equipment at a show



If you Raised your Hand....

Then you likely have the same problem I have, and you do not even know it. Let's talk and review this in detail

In Principle Deep Frame Dimensions are "Standard"

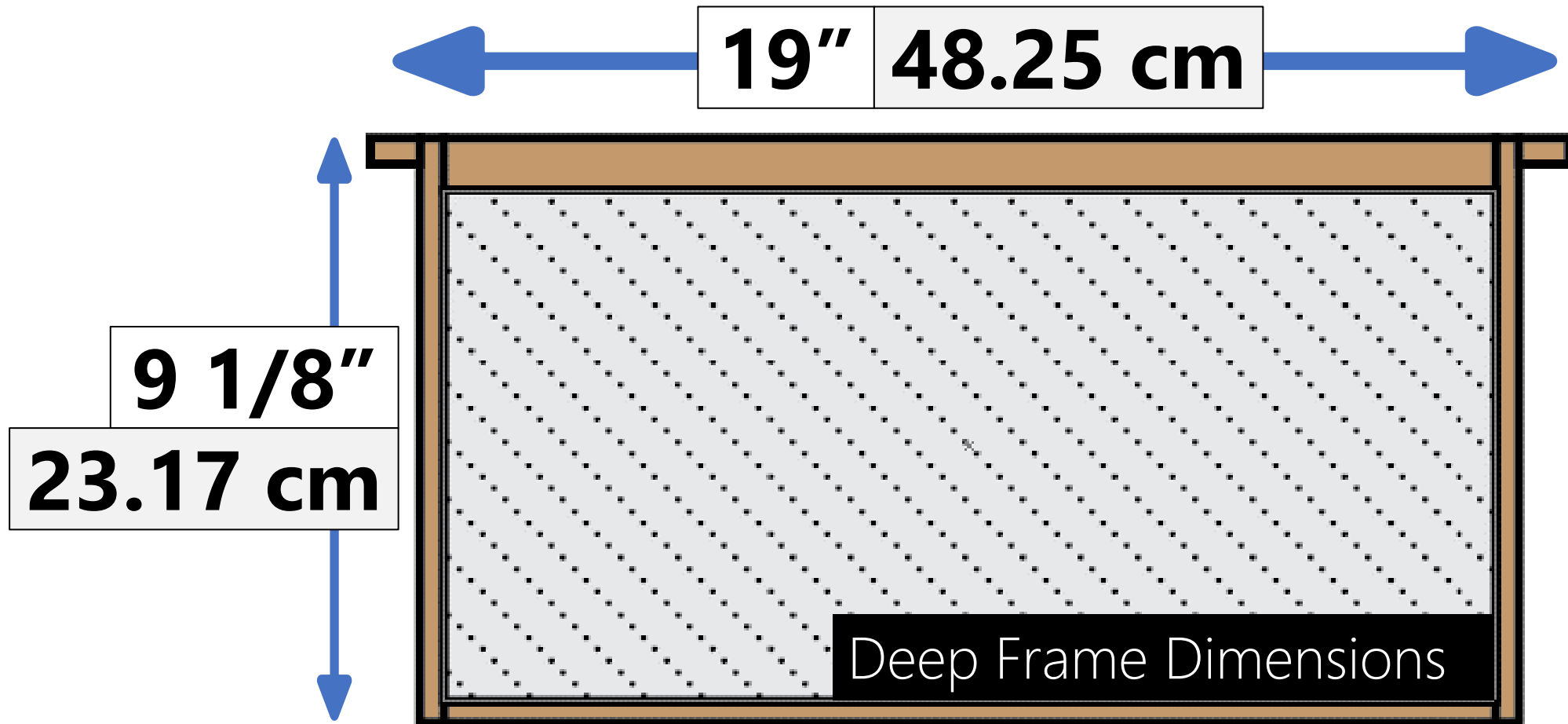

But once again the devil is in the details. **Frames can differ in Dimension and Design**

In Practice Real World Experience Varies

DEEP END
BARS ARE...

9 1/8"

23.17 cm

By the way, the frames in this photo were not staged.

I simply took 10 random frames that I had been cleaning and hung them between two rails.

It is solely what I had laying around.

❑ If you pull a mix of frames from your hives....

- *They might look a little haphazard in length - **something like this...***
- *In practice you will likely find that they can vary from as much as **1/4** to **3/8ths**.*

BEE SPACE VIOLATIONS

The perils of getting it wrong. Mismatch Equipment Problems

A Closer Examination of Frame Designs

Ear Shape & Sizes Differs

- Standard 1/2" (1.27cm)

Sometimes tapered..., Sometimes not...

These hang differently in the hive boxes due to their shape

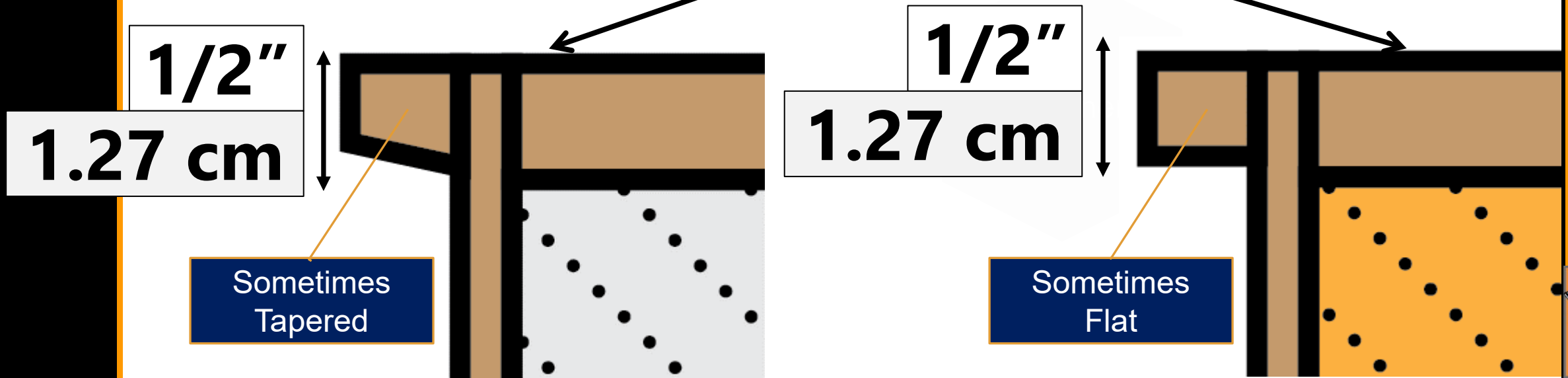

A Closer Examination of Frame Designs

Ear Shape & Sizes Differs

- ❑ Standard 1/2" (1.27cm)
Sometimes tapered..., Sometimes not...
- ❑ Sometimes 3/8" (.95cm)
This measurement is still present in industry

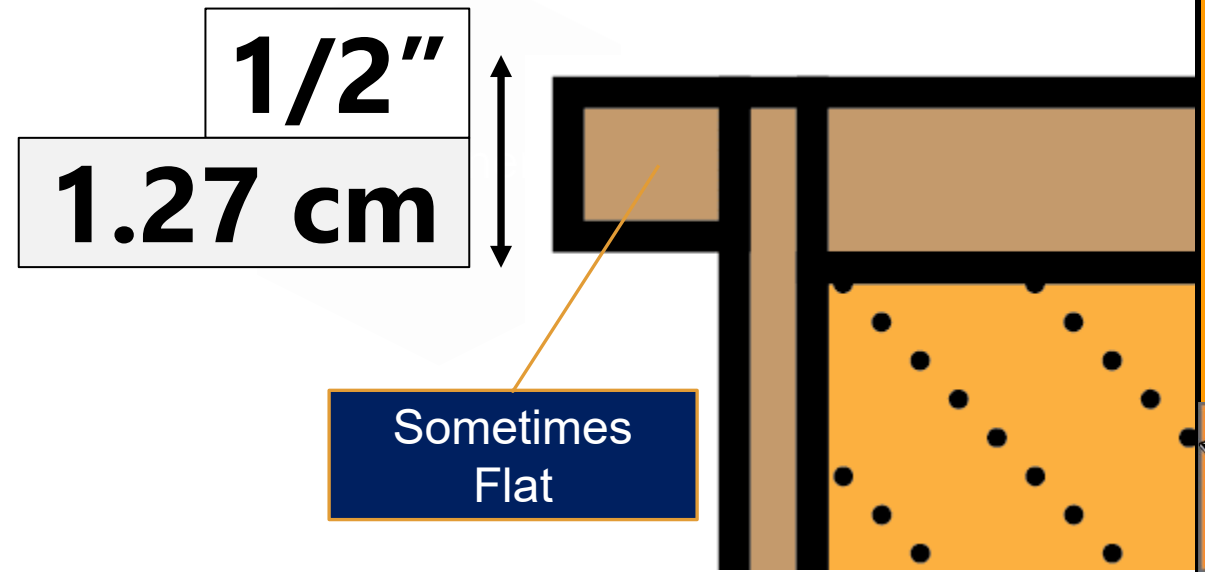
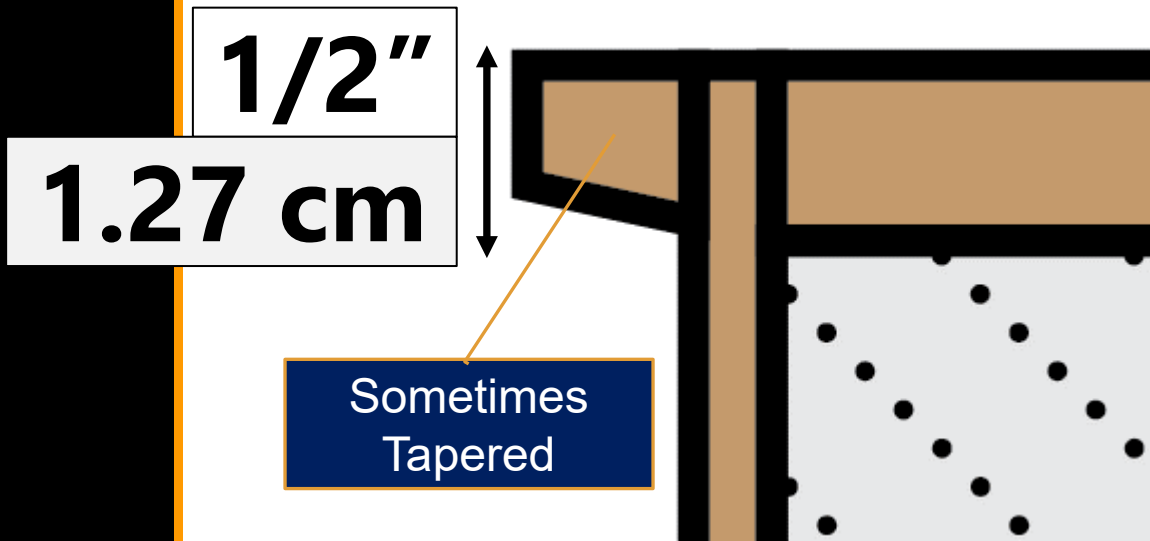
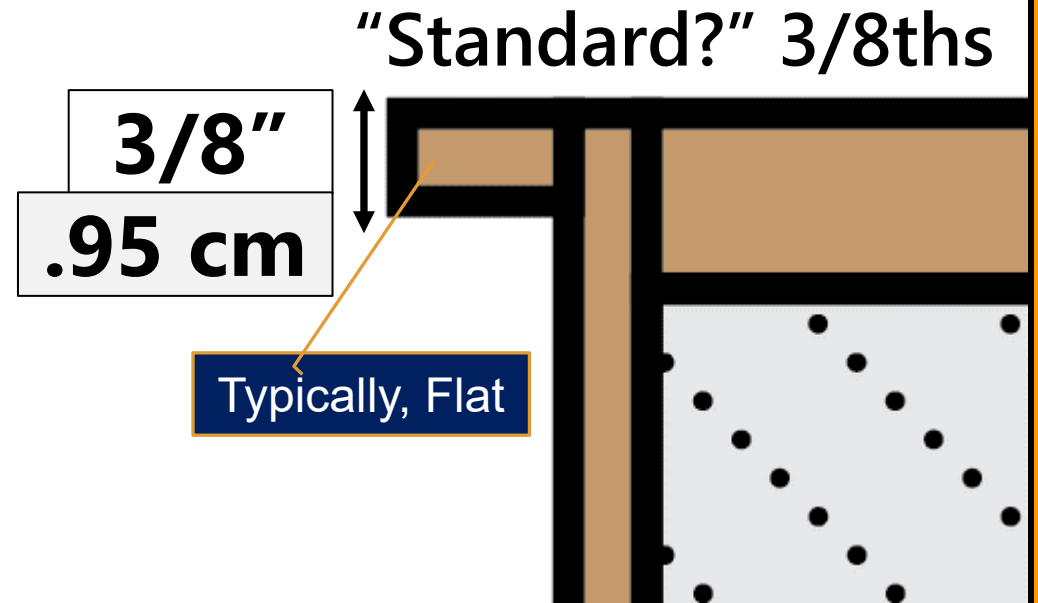

Exploring Mismatches

Mismatch Problems

- ❑ Mismatches causing alignment problems
 - Intermixing **1/2 inch tabs** with **3/8 inch tabs** cause gap differences.
 - Mix and matched **frame rests** also impact how the frame hangs in the box

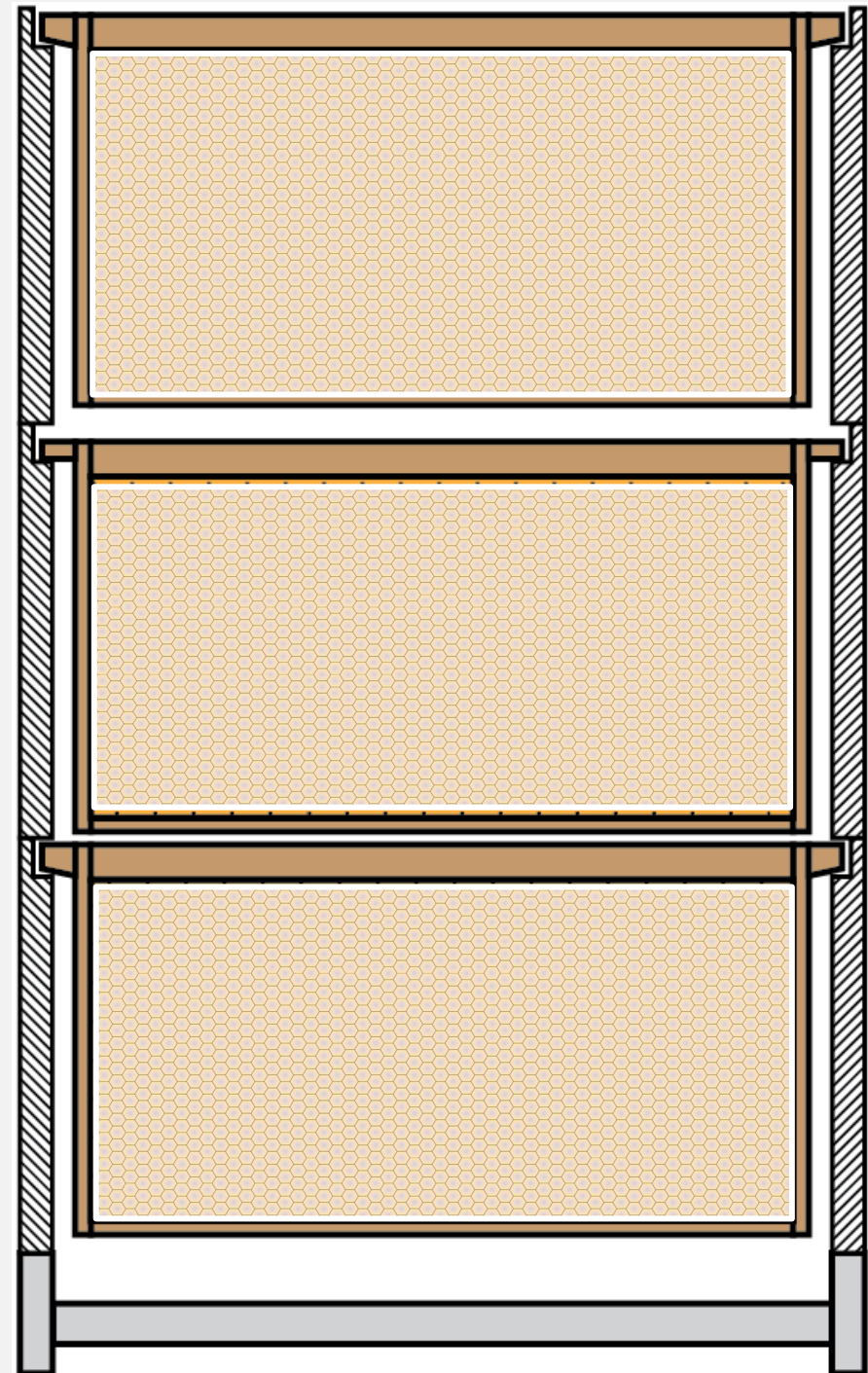

Exploring Mismatches

Mismatch Problems

- ❑ Mismatches either open gaps or squeeze space



A
LITTLE
HELP
HERE...

**Bee Space
Matters**



Exploring Mismatches

Mismatch Problems

- ❑ Mismatches either open gaps or squeeze space

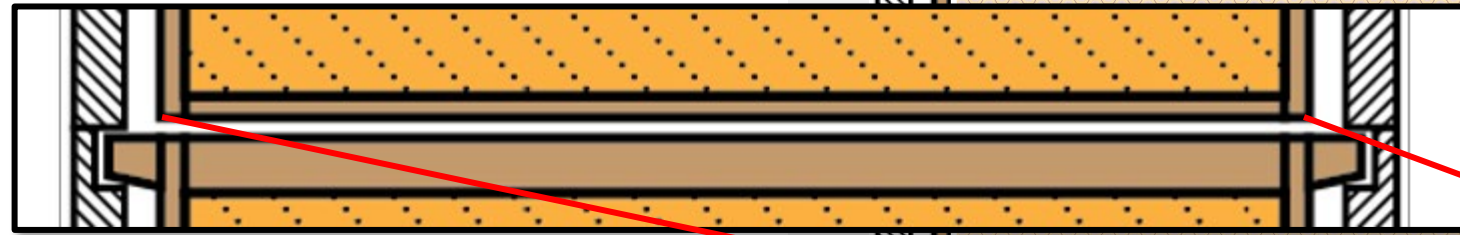

OUCH!

Bee Space Matters

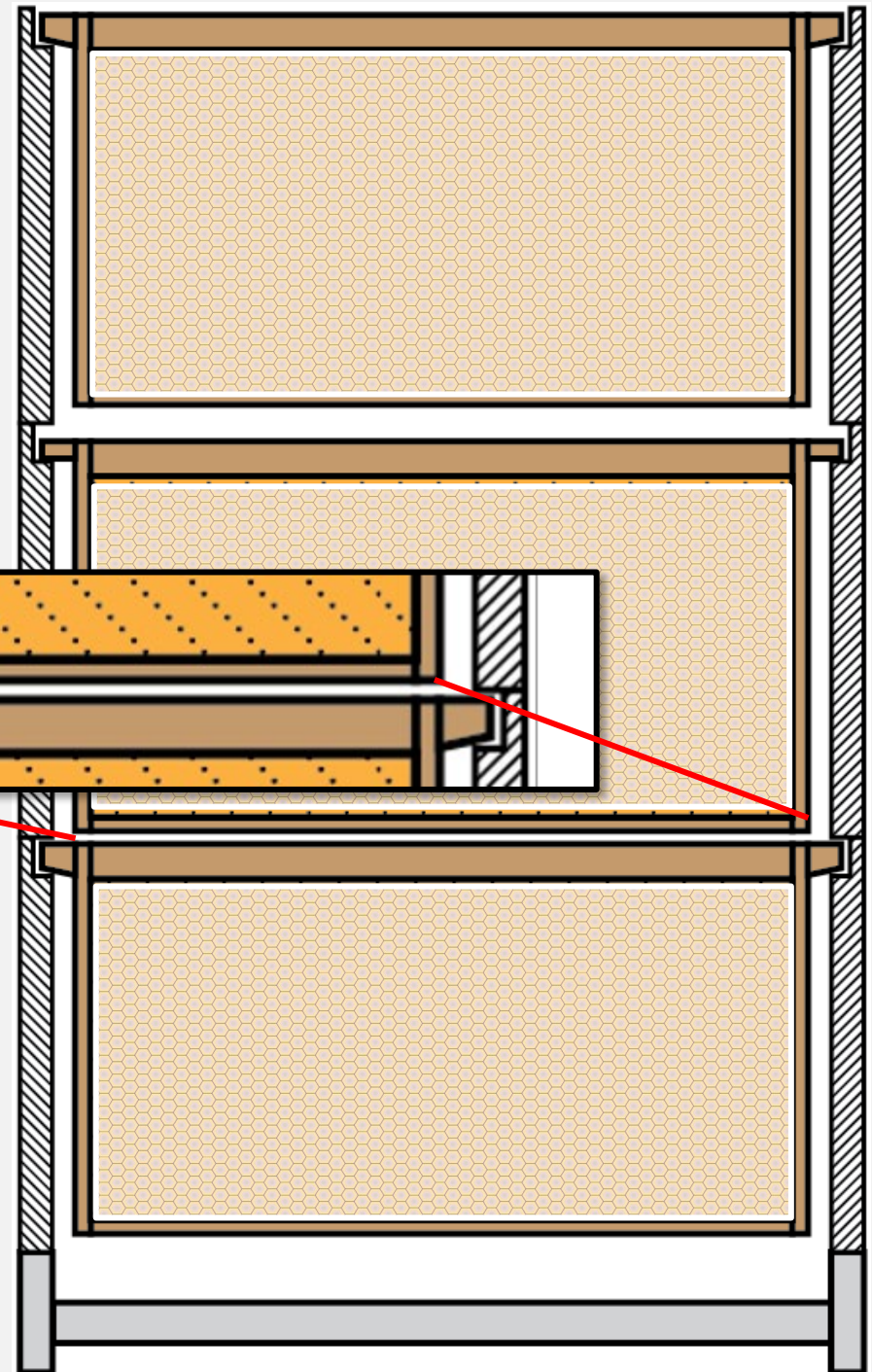
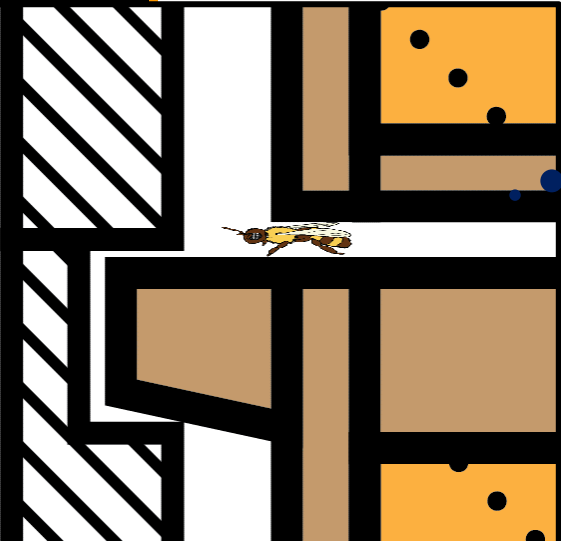

Real Gap Problems

Bridge Comb Under Frames



Real Gap Problems

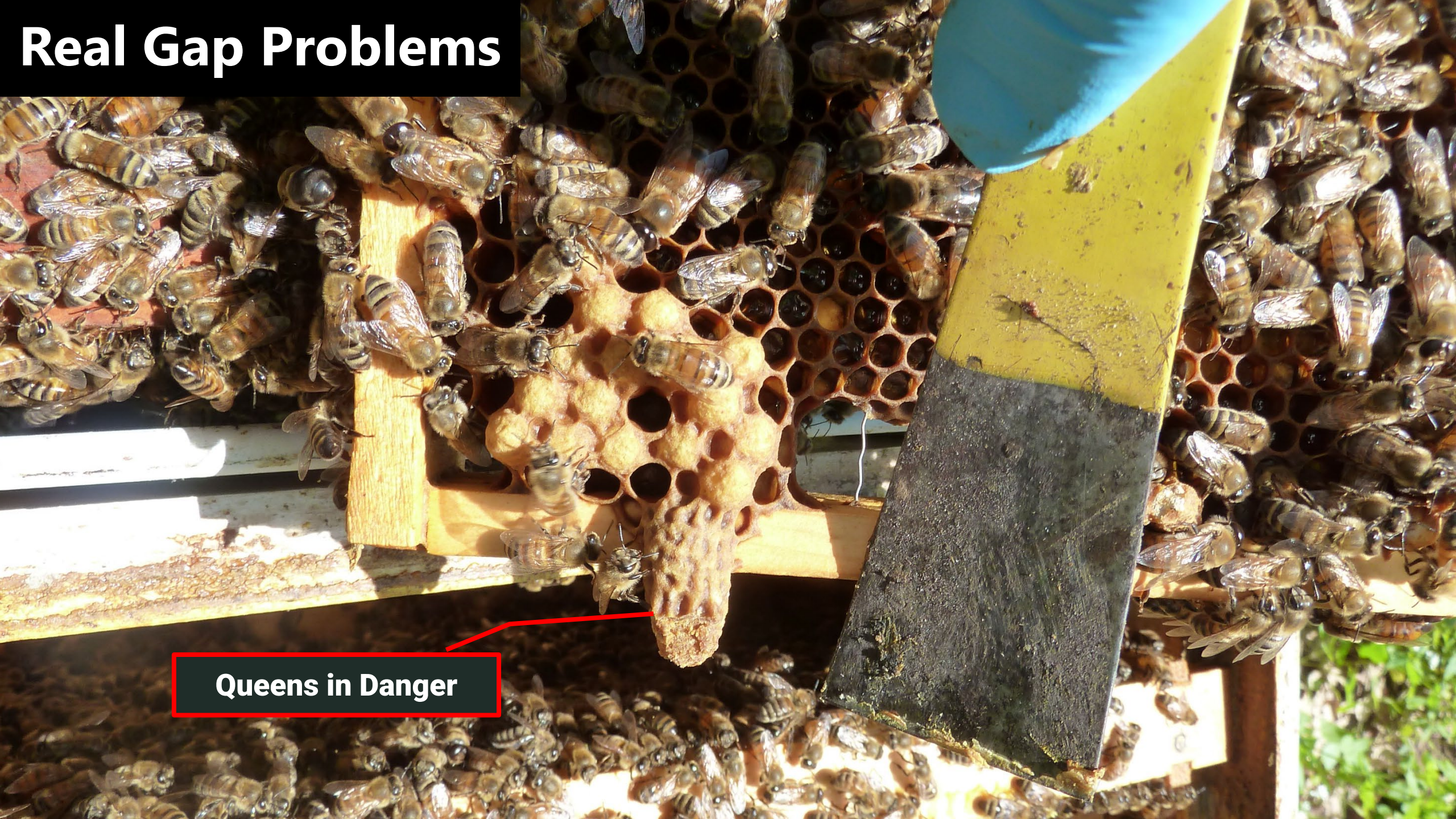

Queens in Danger

Real Gap Problems



Queens in Danger

Real Gap Problems

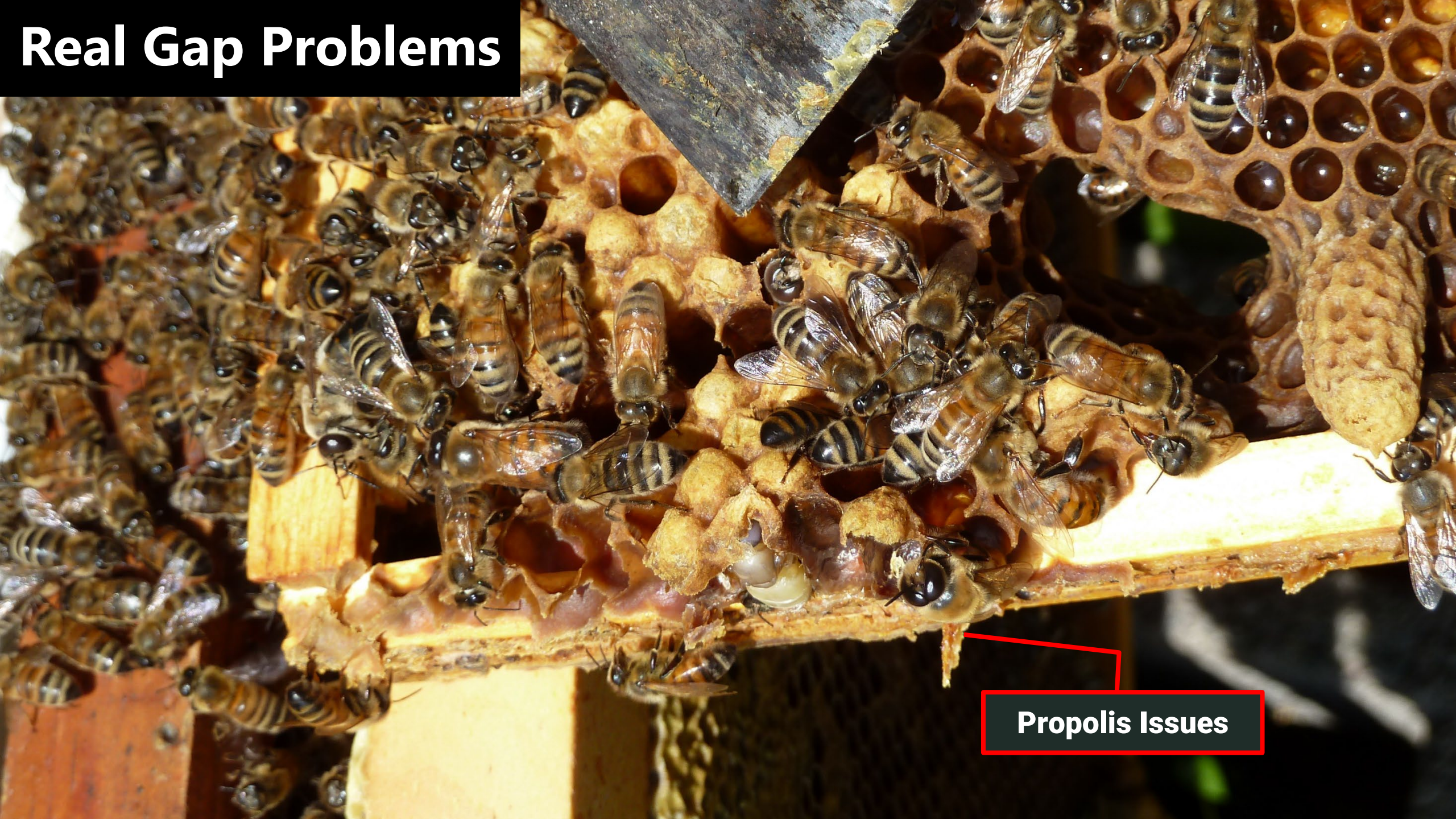

Propolis Issues

Frame Width – *Is that a PROBLEM?*

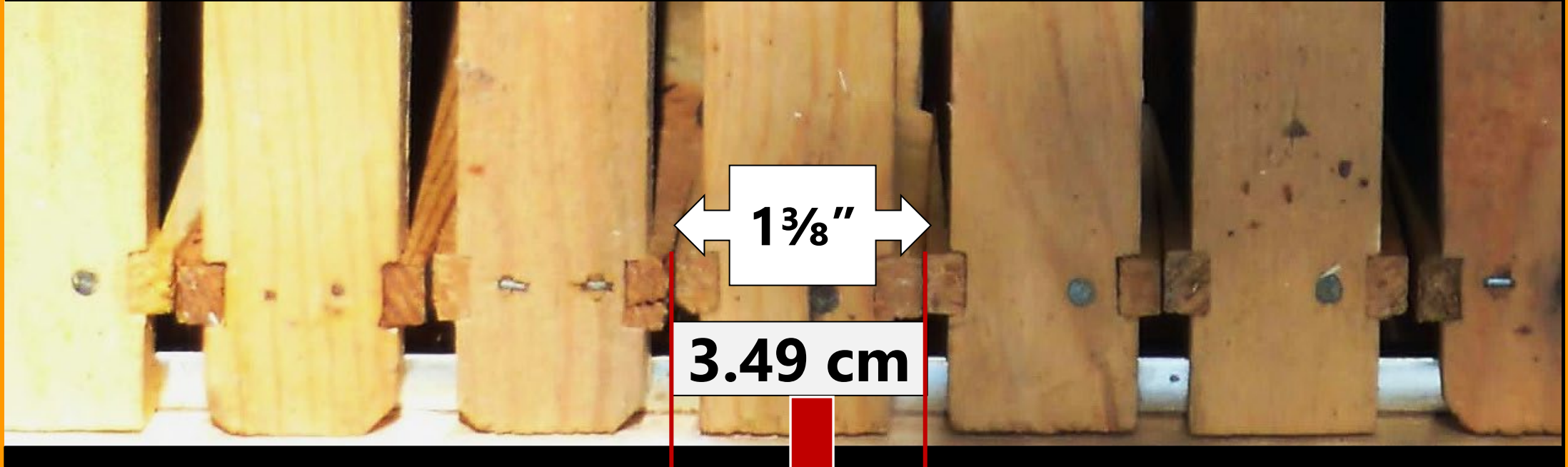

- ❑ What about side to side – SHOULDERS ACROSS?
- ❑ Here it seems things are truly universal, ***so technically NO***
 - *No discrepancies seen after measuring dozens of frames:
Every frame end bar was 1 3/8" (3.49cm).*

{ Thank you
Julius Hoffman }

Wait... What's this?

- What do we see here?
 - Apparently **11 frames** is a 'thing'...
 - Some manufacturers are offering frames that have **1 ¼-inch (3.17) shoulders**
 - **This is in direct opposition to the standard 1 3/8ths**



Image credit: John Ferguson

Wait... What's this?

□ Why?

- 11 frames – **more cells, more bees**
 - More real estate; Population Increase Benefit
- 11 frames – **more cells 'more resources'**
 - More real estate; More cells to put more nectar and pollen
 - Not really sure if this nets out....
- 11 frames – **tighter confines: small bees**
 - Smaller Bees – less days to develop which is better for Varroa Mites: **fewer generations**

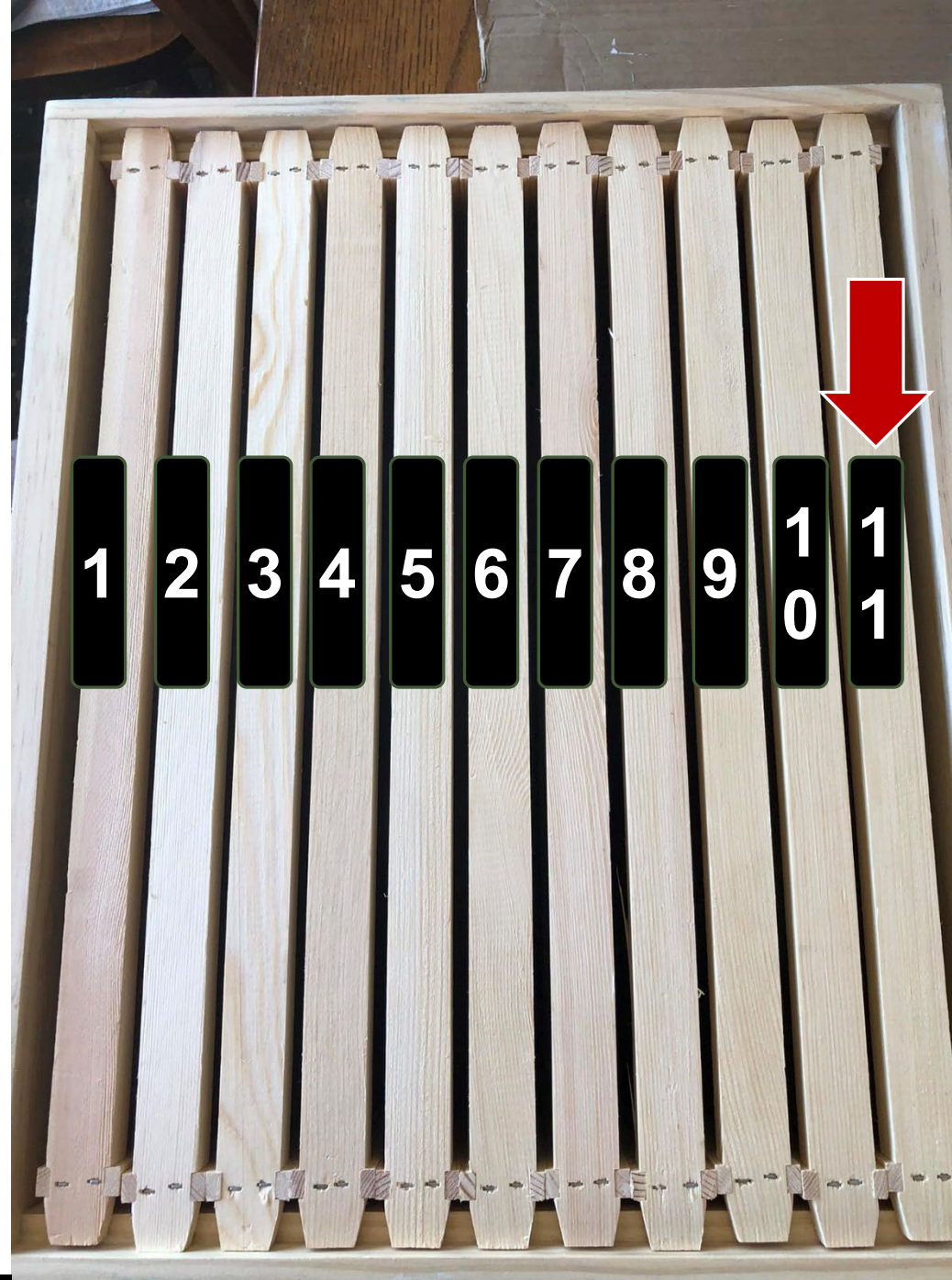

Image credit: John Ferguson

CONSTRUCTION & ADVICE

What you buy, and who you buy it from, is an Critical Consideration

So, it seems things *might not be so universal...*

❑ Consider Your Options:

STAY WITH ONE VENDOR

- *The best way to 'bee' in harmony*
 - When it comes to woodenware (Boxes, Frames, Roofs, Bottom Boards, etc.) **stay with one vendor**
 - **With big supply houses, they ensure that the full stack equipment is constructed to work together**
 - The tolerance of bee space will be compatible
 - ❑ **This is especially important as years progress in your beekeeping, and you exchange equipment from one hive to another**

Stay with a one vendor for woodenware and you will be head of the pack when it comes to:
THE FRAME GAME

Consult your local Bee Club for relevant vendor recommendations



MANN LAKE



Frame Vendor & Foundation Marking

❑ **Tip:** Code your Frames

- *I use a Sharpie to mark my frames.*
- *Frames are encoded with the manufacture code and foundation information*
 - **F 6/23** = Foundation Installed June 23 (6/23)
 - **BB** = BetterBee Frame
- *One Additional Tip:*
 - The marked end of the frames always goes to the front of the hive. I never put frames back in the wrong orientation



A photograph of a wooden box under construction. The box is made of light-colored wood and is held together by several blue and yellow clamps. A red strap is wrapped around the middle of the box. The text 'Build Boxes True' is overlaid on the image in a black box with white text.

Build Boxes True

- ❑ Boxes that are:
not square and not true
will cause space problems
 - *Twists cause distortion gaps*
- ❑ Non-Square, oblong boxes
 - ***Can lead to frame misalignments and spacing issues***

Consider Clamping Systems

□ Corner and Woodworking Clamp **Benefits**

- *Lock in Square and True, then drive the fasteners*
 - Consider the benefit of wet assembly with glue, and then clamping the box pieces.
 - Clamping can guarantee that a piece stays square and true.
 - It also makes it easier as they hold the piece, freeing up your ability to drive the fasteners
 - Clamping also applies force at the joints and this is suggested that the pressure at the joint glued surfaces results in a better bond.



TRIM HEAD SCREWS....



Have you ever considered?
TRIM HEAD SCREWS



Consider that: Screws are easier to fasten and aid you to build boxes square



TRIM HEAD SCREWS....



What if you used screws instead of nails?

- *Would you need to glue the box?*
Um, NO...
- *If something went wrong, could you back it out and fix it?*
Um, YES...
- *How do I know. **This is what I do...***
 - *Incidentally, they do not rust...in case that might be a question you are pondering*

Have you ever considered?
TRIM HEAD SCREWS



Consider that: Screws are easier to fasten and aid you to build boxes square



Consider a JIG or CORNER CLAMPS

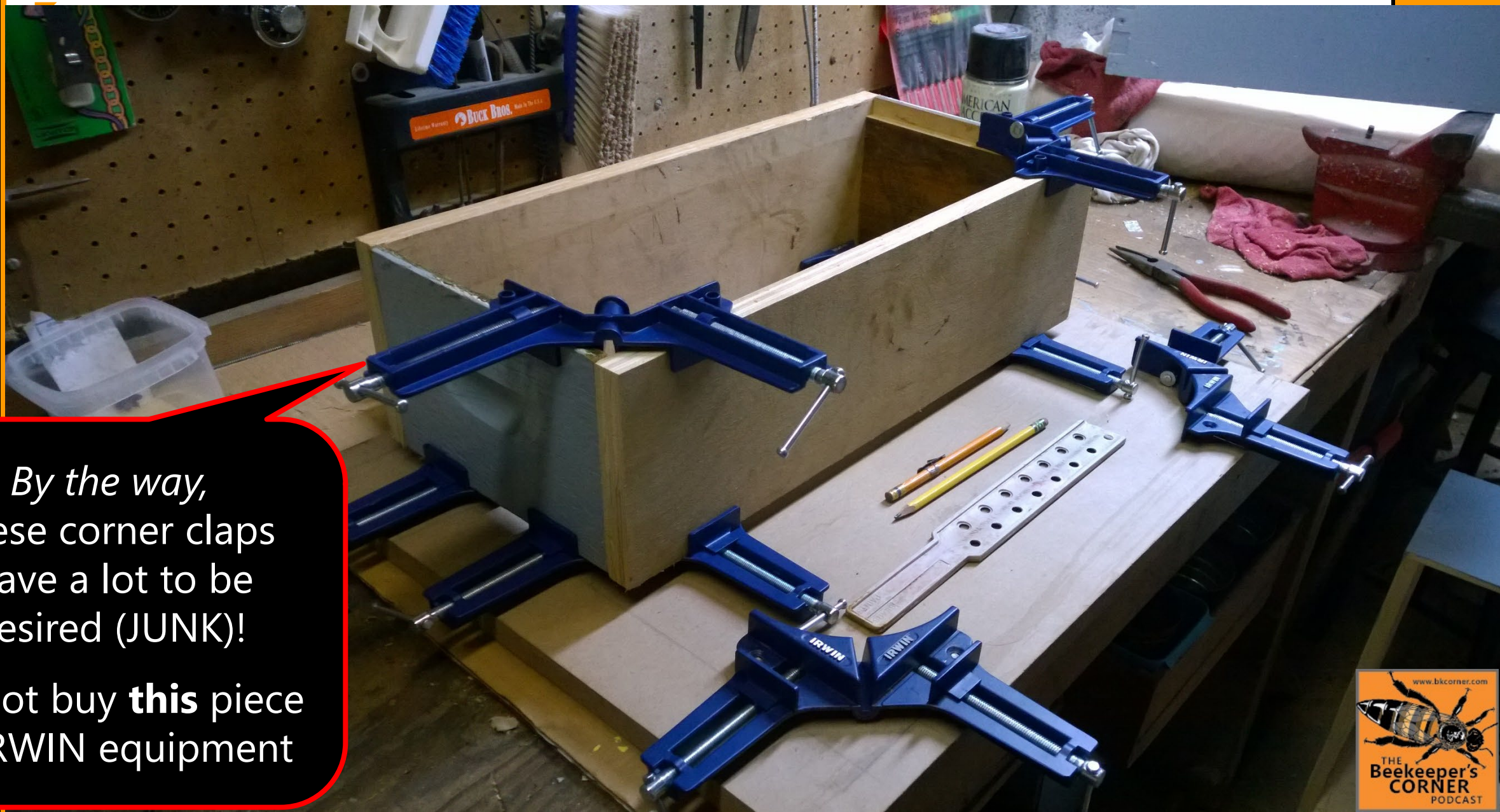

By the way,
These corner clamps
leave a lot to be
desired (JUNK)!

Do not buy **this** piece
of IRWIN equipment

The Frame Game: Variations Abound

Top Bars

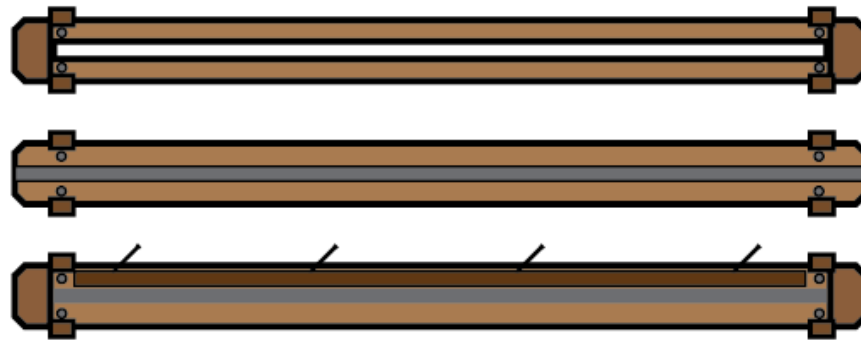

Slot
Groove
Wedge

Bottom Bars



Slot
Groove
Slot 2
Solid

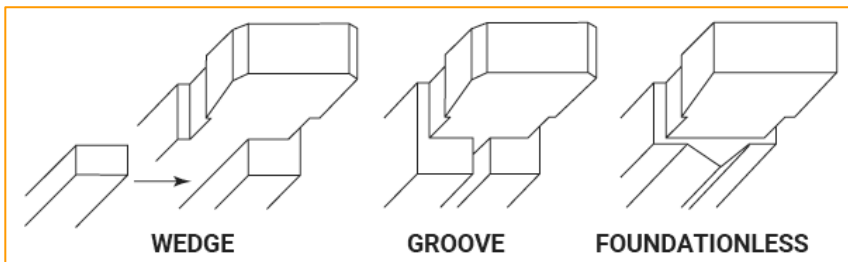

Settle on a type

❑ Frame offerings vary widely

- *Settle on a type of Frame Design **and stick with it.** and **buy foundation from that Frame Supplier***

❑ Wedge Frames are the standard

- *Combined with crimp wire foundation*

Get the Right Foundation: Frames and foundation

Deep Size Examples

- ❑ **Wedge Bar | Divided Bottom**
 - *Uses wired **8 1/2"** foundation with hooks*
- ❑ **Slotted Top Bar | Grooved Bottom**
 - *Uses wired **8 7/8"** foundation with no hooks*
- ❑ **Wedge Bar | Solid Bottom**
 - *Uses wired **8 1/8"** foundation with hooks*
- ❑ **Wedge Bar | Grooved Bottom**
 - *Uses wired **8 7/16"** foundation with hooks*



Foundation
Varies!

Foundation Varies!

**Put the wrong size in...
You get '*banana comb*'**

This is extreme for illustrative purposes; *however*, I have seen this in other people's hives.

Out of square frames cause bee space problems

- Twists cause *distortion gaps* and *raised bottom bars*

❑ Consider a **Frame Jig**

- They are really a good way to go
- Available in most catalogs these days

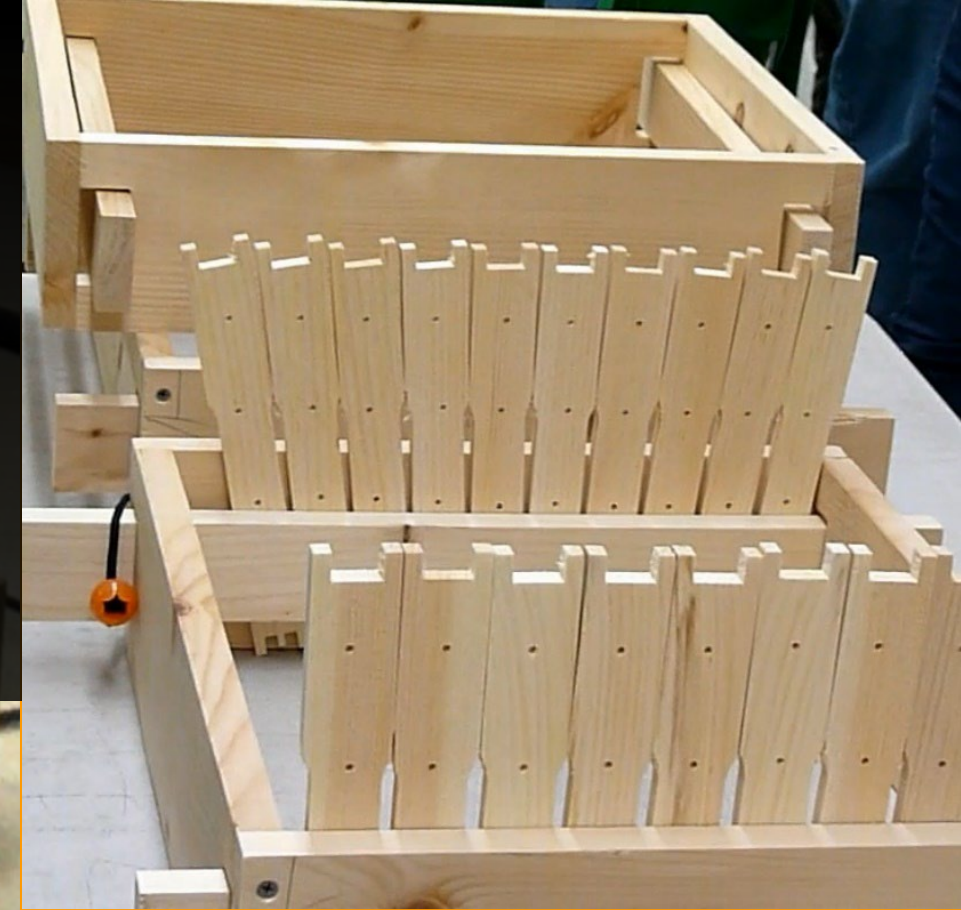

Locking in a Square Frame

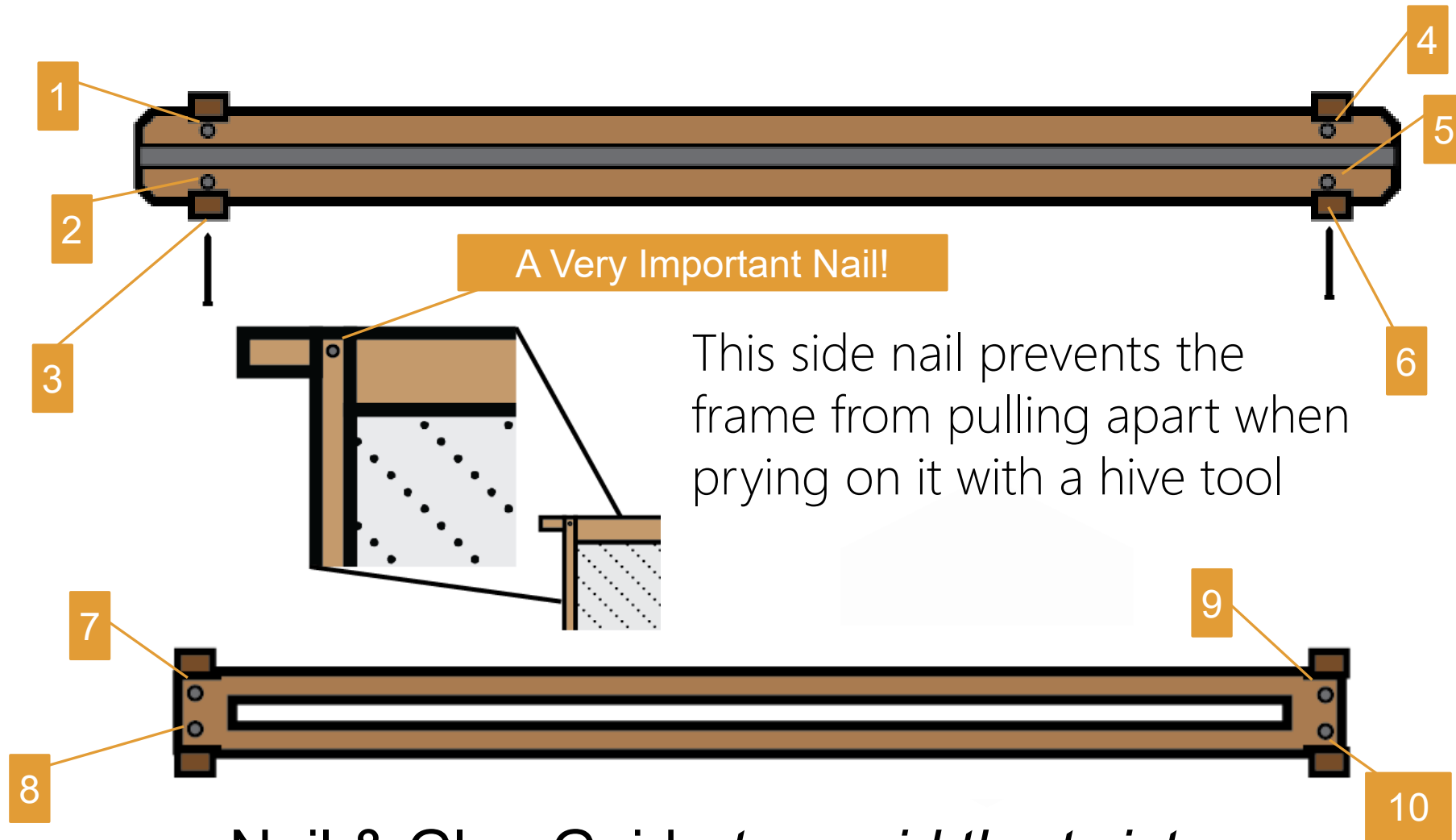

Nail & Glue Guide *to avoid the twist*

Side Nail Expanded

The side nail prevents the frame from pulling apart when prying on it with a hive tool

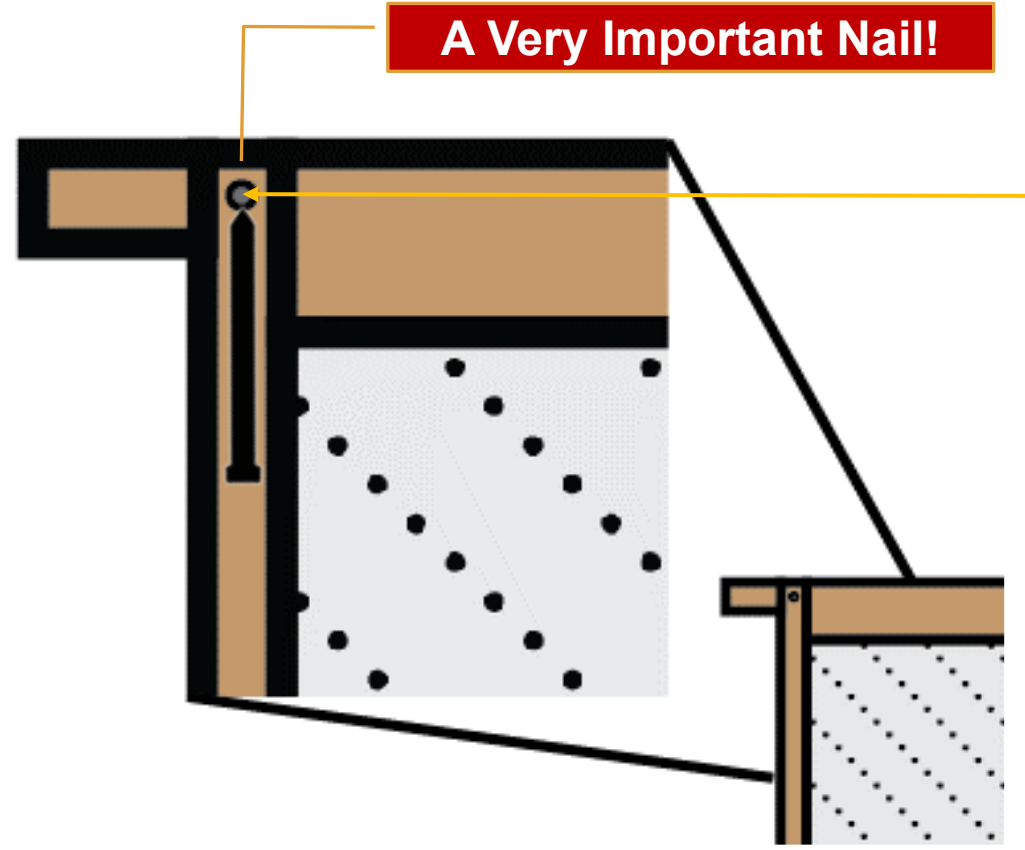

It can be placed through the end bar, just under the ear of the top bar so the nail locks into the top bar (*right*)

Or it can be placed into the ear of the end bar, passing into the top bar to lock it in (*left*)

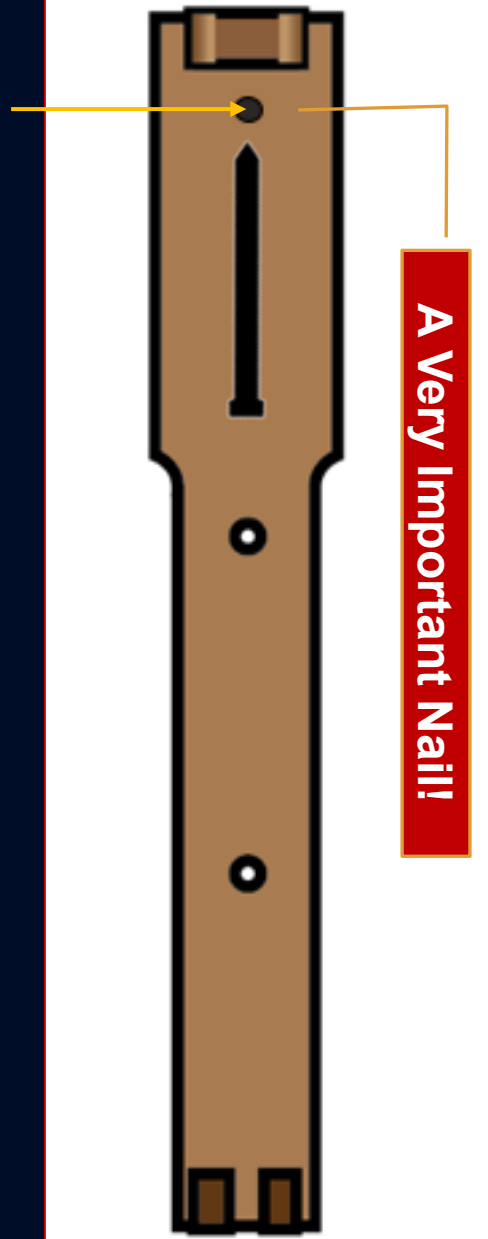

Maybe Pre-Made?

□ Square and True

- *Not a good woodworker?*
- *Premade Frames are a good option in general*
 - Whether plastic or Wax Foundation
 - Premade frames are letter perfect right from the factory
 - They save time on your part and they are not that much more expensive



PROBLEM AVOIDANCE

Some wisdom and guidance to consider to keep out of trouble



Avoid Slots and Grooves

Grooves in frames, **top or bottom**, are not your friend. They encourage excess comb and propolis in the wrong places. *Troubles from above, troubles from below....*

**Bad
Evil
Things
Happen
With
Slotted
Frames**





Doing a hive inspection with my friend Charley

This is the catalyst to and episode of the frame game.

Look at the hive boxes in his apiary. Take in what they look like...

Top Box = No Good

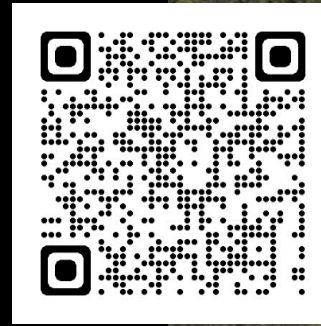

❑ This particular hive deep came by way of Charley

- *Charley's equipment was not compatible with my vendor's equipment*
 - The frame rests from his equipment were very deep.
 - This resulted in the frames hanging down too far
 - They came into contact with the top bars of the frame sitting below them. **The bees propolized them together**
 - When I tried to take the box off, the frames below came up when the top box was pulled
- *Needless to say – the situation went downhill*



✓ Suggestion Put offenders Under the Stack

- ❑ If you have non-standard boxes...*like this one*
 - One thing you can do is place non-standard boxes at the bottom, over the bottom board.
 - The gap over the bottom board is forgiving and it allows you to use an errant box or set of frames.

I am still friends with Charley :-)

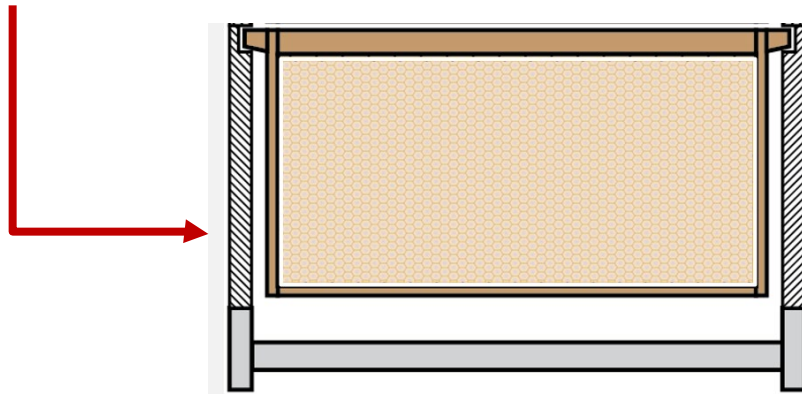

What about Foundationless?

- ❑ Place a top bar with a comb guide to coax the bees to build their own comb – *no foundation*.
 - Place it between two drawn out frames for best results.
 - Could use popsicle stick in a slotted top bar too!

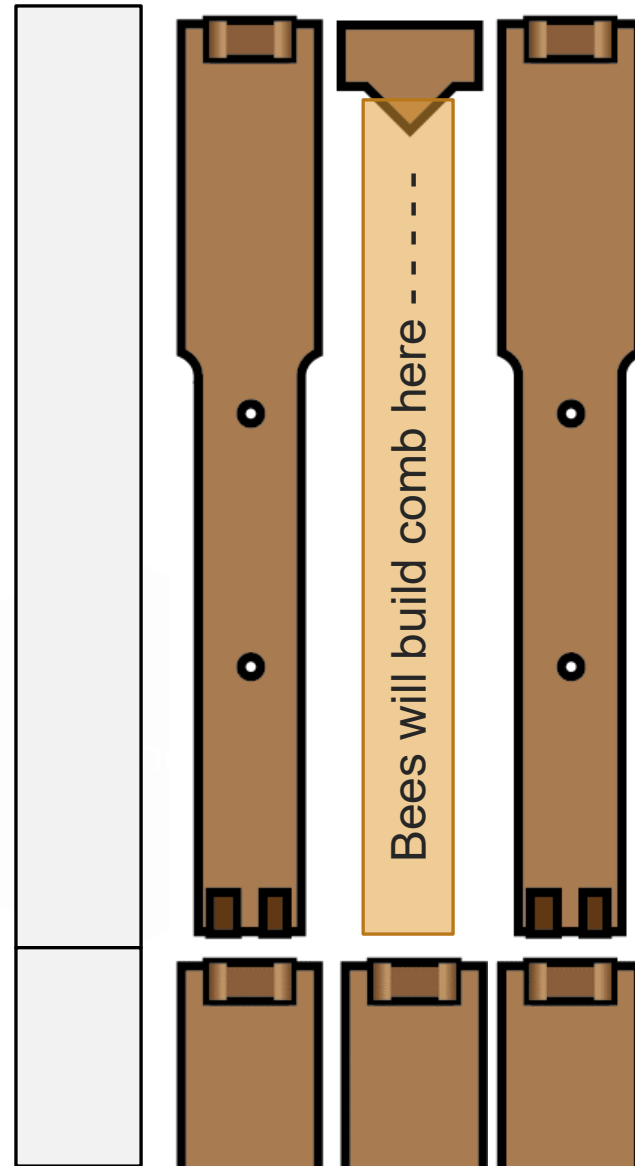

Wyatt Mangum's Work

Migration of the mid-rib

- *Wyatt's recent Bee Culture article discussed the dynamic of the progression of the mid-rib*
- *The farther they build down the line, the more the mid-rib pushes off center.*

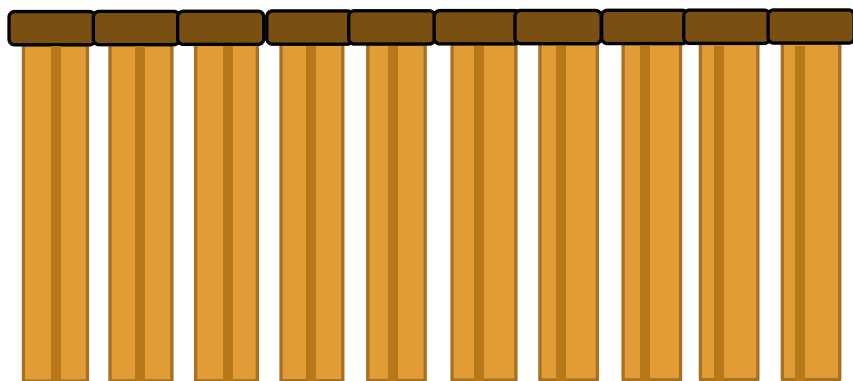

For the Top bar beekeepers



Thickness of frames wax determines how deep the bees build the cells on a comb face

Wyatt's fix > *Rotate frames that require comb up into the middle of the brood chamber for more a more consistent mid-rib build out.*

Mind the Gaps!

❑ Keep your frames tight and centered

- *Use a hive tool to push the frame together so the shoulders touch*
- *Even the space on both sides*
 - If you keep the frames pushed to one side it could result in a gap between the frame and outer wall
 - With the violation of bee space, the bees will attach this to the hive box

Nestle the frames together and center in the box

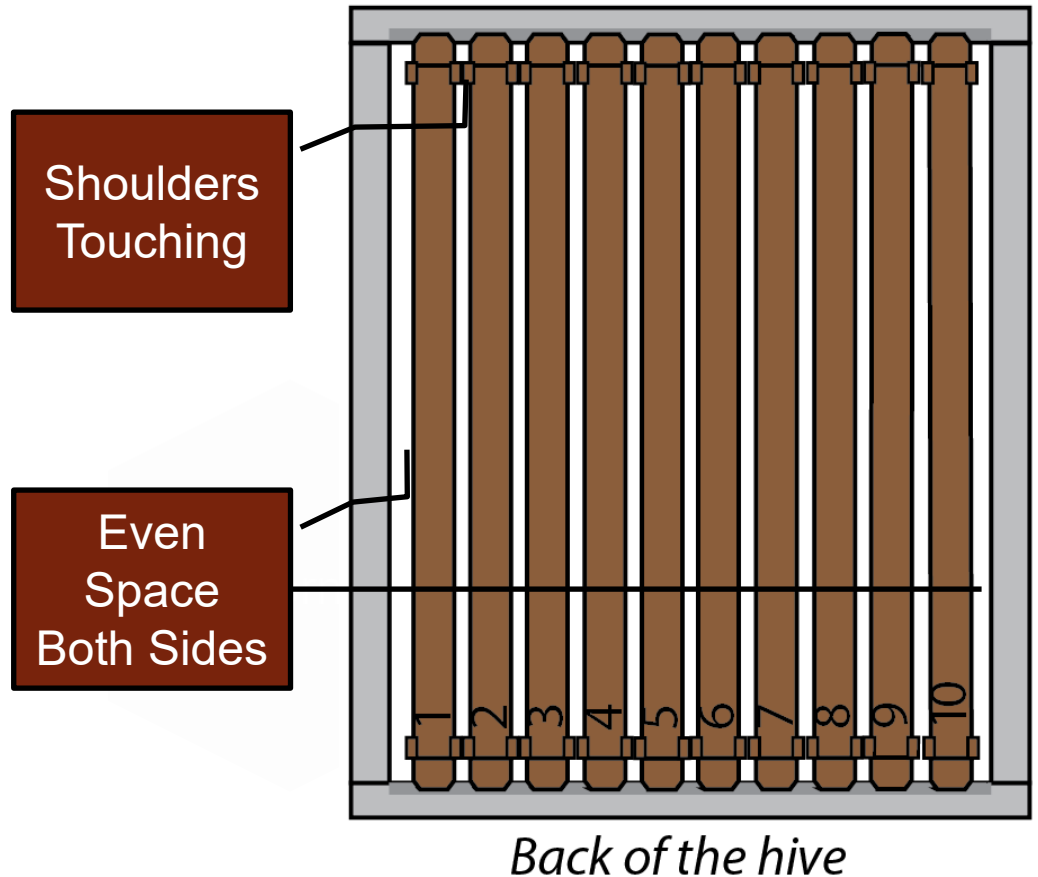
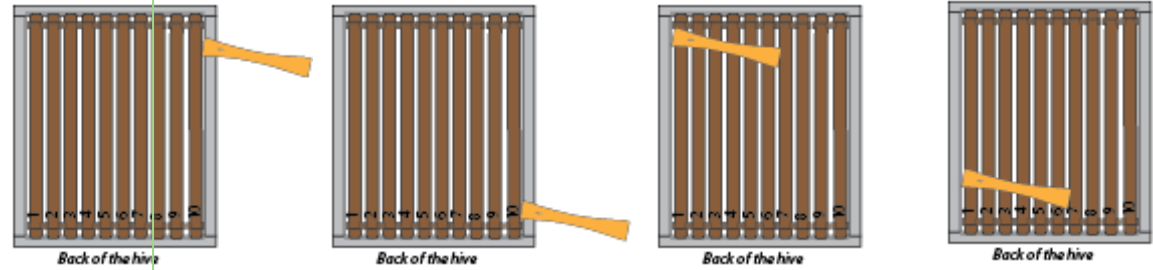

Kevin Moment:

This was part of the My Frame Game *2020*
At the time, I went through 95% of all in service frames

Frames that were off measurement wise went in the bin

Broken and/or loose frames were repaired or discarded

All Plastic Foundation went in the bin

Frames found from as far back as 1995!

I thanked the comb for the years of service, and then pitched it

No foundation in any of my hives is older than 2020



Melting the Wax Combs



Mounted to an old wheelchair



Forever Chasing It

□ Hive Boxes in Storage

- *I am always organizing my frames into action plans*
- *Tracking through Blue Tape...*
 - Each fall when the season comes to a close, I spend time in the garage **going through frames** that require my attention
- *I will take the time to inspect and clean each frame scrupulously*

No better feeling then to have frames on the ready in spring





▶ A Different kind of Frame Game

❑ Sometimes the idea is to break the rules.

- *Some beekeepers are considering building frames that span boxes. Custom sidebars that cross two boxes.*
- *Recreating the Modified Dadant / Dadant-Blatt brood frame*

<http://www.canberrabees.com>

- Eric from Canberra Bees is cutting end bars with lasers and experimenting with these frame ideas.

Visit his forum for more info.

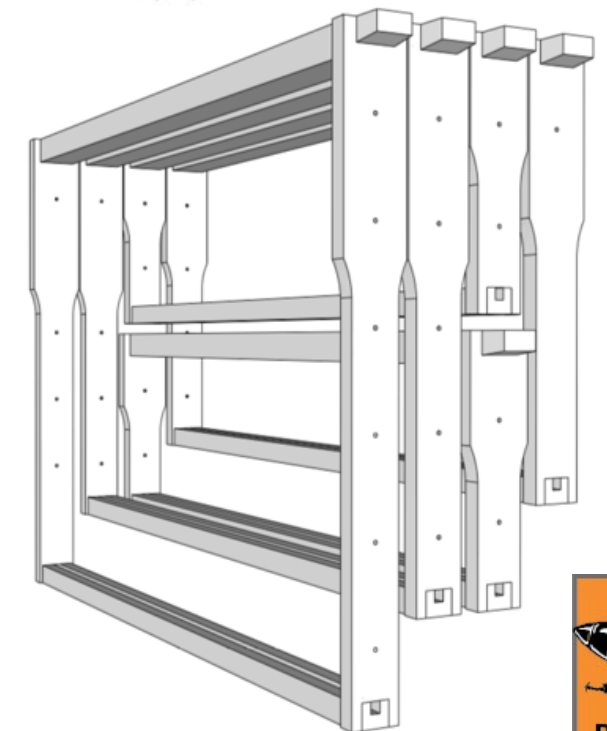

FRAMES

They are the heart of the hive

Build your equipment well (or buy it)

- *If you are not that good with wood.... Let them build it for you?*

Use One Manufacturer: Frames and Boxes

Follow these tips:

- *Build Square and True. Build equipment with jigs and use woodworking squares and/or clamping systems.*
- *Mark your frames with manufacturer info and year*
- *Use the right frame rests*

❑ **Donate mismatches to a good cause**



QUESTIONS

EMAIL

Kevin@BKCorner.org

WEBSITE

www.bkcorner.org

This presentation is
available to download.

Search the website for
presentations or click the
presentations link